

# IFAM



**CATÁLOGO GENERAL CG.01**  
GENERAL CATALOGUE CG.01



## Introducción

### Introduction

IFAM, calidad y servicio - IFAM, quality and service	4
Simbología - Simbology	6
Condiciones de venta - Sale conditions	7
Novedades - New products	8

## Cilindros

### Cylinders

Serie WX1000 - WX1000 Series	10
Serie NK1000 - NK1000 Series	13
Serie M+ (Anti Snap) / F6S+ - M+ (Anti Snap) / F6S Series	14
Serie M / F6S - M / F6S Series	16
Serie Huno - Huno Series	19
Serie D - D Series	20
Serie F5S - F5S Series	22
Cilindro eléctrico M27x45 - M27x45 electric cylinder	24
Accesorios - Accessories	25

## Cerrojos, Cerraduras y Escudos

### Rim Locks, Locks and Escutcheons

Cerrojos - Rim locks	28
Cerraduras de embutir - Mortise locks	33
Picaportes - Latches	35
Cerrad. lengüeta - Cam locks	36
Escudos - Escutcheons	37
Accesorios - Accessories	41

## Candados

### Padlocks

Alta seguridad - High security	44
Seguridad - Security	46
Serie K - K Series	48
Serie Tifón - Tifon Series	50
Serie Z - Z Series	52
Serie Steelus - Steelus Series	53
Resistencia a la corrosión - Resistance to corrosion	54
Diseño y combinación - Design and combination	58
Portacandados - Hasps and staples	68

## Seguridad industrial

### Industrial Safety

Candados LOTO - LOTO padlocks	72
Pinzas LOTO - LOTO hasps	75
Bloqueo mecánico - Mechanical lockouts	76
Bloqueos eléctricos - Electric lockouts	77
Otros productos LOTO - Other LOTO products	78

## Antirrobo para moto

### Motorcycle locks

Antirrobo de cadena y anclajes - Chain loscks & anchors	82
Antirrobo de rótulas - Ball-joint locks	86
Antirrobo de disco - Brake disc locks	87
Otros antirrobo para moto - Other motorcycle locks	92

## Antirrobo para bicicleta

### Bicycle locks

Antirrobo para bicicleta - Bicycle locks	94
--	----

## Complementos de seguridad

### Security complementary products

Mirilla digital - Digital door viewer	102
Guardallaves - Key storage	102

## Servicios

### Services

Servicios de llaves IFAM - IFAM key services	
Amaestramientos IFAM - IFAM Master keying service	106
Solución de llave única - Unique key solution	108
Pedidos de llaves IFAM - IFAM key orders	110
Expositores - Product stands	112

## La experiencia de un fabricante

The experience from a manufacturing company

Fundada en 1948 en Mondragón (España), IFAM es líder en el mercado español de cerrajería. La empresa inició su actividad con la fabricación de candados, producto con el que consiguió un gran prestigio. Progresivamente, IFAM fue ampliando su línea de productos con la fabricación y comercialización de cerrojos, cerraduras, cilindros para puertas, antirrobo para moto y bicicleta y complementos de seguridad.

Established in 1948 in Mondragón (Spain), IFAM is the leader in the Spanish locksmith market. Since the very beginning the company produced padlocks and achieved soon a great prestige as a manufacturer. Progressively, IFAM expanded its product lines by manufacturing and selling locks, rim locks, door cylinders, motorcycle and bicycle locks and security complementary products.



## Una amplia gama de servicios

A wide range of services

Junto a un catálogo amplio y variado de productos, IFAM ofrece una gama muy diversa de servicios, con el fin de responder a las necesidades de sus clientes. En servicios de llaves, IFAM ofrece sus productos en llaves iguales, llaves desiguales, número determinado y amaestradas. Mediante el servicio de amaestramiento de llaves IFAM proporciona soluciones a medida para el sector de la construcción, centros educativos y deportivos colectivos... Además, IFAM es reconocida en el mercado por la agilidad de su servicio, que permite a sus clientes recibir sus pedidos en plazos muy cortos.

Besides a wide and varied catalogue of products, IFAM offers a very diverse range of services, in order to meet the customers' needs. Regarding to the services related with keys, IFAM offers its products keyed alike, keyed dislike, under a certain key number and master keyed. Through its master keying service, IFAM provides tailor-made solutions for the construction sector, sport and educational centers, communities... In addition, IFAM is recognized in the market for the agility of its service, which allows its customers to receive their orders in very short deadlines.



## Compromiso con la calidad y la innovación

Commitment to quality and innovation

En IFAM, la búsqueda de la máxima calidad en sus productos y servicios es una constante. Prueba de ello son los certificados de calidad con los que cuenta, emitidos por entidades independientes, como las certificaciones ISO o las acreditaciones de su línea de cilindros para puertas, emitidas por los laboratorios Tecnalía.

Para alcanzar la máxima calidad, IFAM trabaja en desarrollos propios de producto en su departamento de Ingeniería. Así, la firma se adapta y se anticipa a las necesidades del mercado.

In IFAM, the search for the highest quality in our products and services is a constant. The company earned different quality certificates, issued by independent entities, such as ISO certifications or the accreditations of its line of cylinder doors, issued by Tecnalía laboratories.

To reach the highest quality, IFAM's Engineering department works in new product developments. Thus, the firm adapts and anticipates the needs of the market.



## Una marca presente en más de 50 países

A brand present in more than 50 countries

La internacionalización de la marca es uno de los pilares estratégicos de IFAM, como así lo demuestra su implantación física en 4 países: España (donde se encuentra la sede central del Grupo IFAM, en Mondragón), IFAM Francia, IFAM Reino Unido e IFAM Colombia.

Gracias a sus filiales y una potente red de comercialización en crecimiento, los productos IFAM se hallan presentes en más de 50 países de los 5 continentes.

The international expansion of the brand is one of the strategic pillars of IFAM, as evidenced by its physical implementation in 4 countries: Spain (where the IFAM Group's headquarters are located in Mondragón), IFAM France, IFAM UK and IFAM Colombia.

Thanks to its subsidiaries and a powerful, growing sales network, the IFAM products are present in more than 50 countries on all 5 continents.



### Iconos - Icons

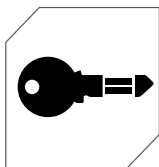

Llaves iguales  
Keyed alike

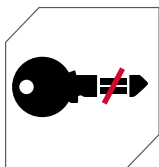

Llaves desiguales  
Keyed dislike

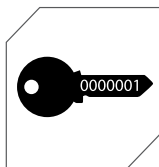

Llaves de nº determinado.  
Certain key number



Amaestramiento simple o de portal  
Simple master keying system

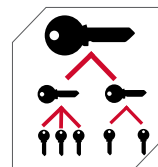

Gran amaestramiento  
Big master keying system



Solución de llave única  
Single key solution

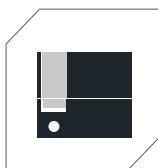

Disponible en medio cilindro  
Half cylinder available

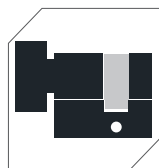

Disponible con pomo  
Thumb turn available

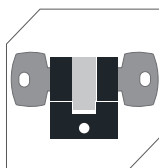

Cilindro de doble embrague  
Cylinder with emergency system

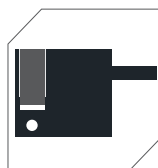

Cilindro con eje regulable  
Cylinder with regulable axis

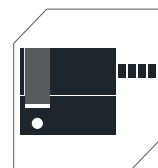

Cil. lengüeta regulable (barras antipánico)  
Cylinder with adjustable tab (antipanic bars)

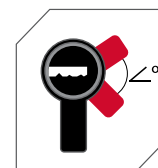

Cilindro ángulo de leva variable  
Cylinder with variable cam angle



Protección antibumping  
Bump proof protection



Protección antitaladro  
Drill proof protection



Puente reforzado antirrotura  
Anti-snap bar

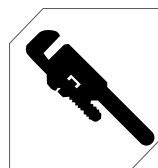

Protección anti snap  
Anti-snap protection

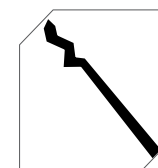

Protección antiganzúa  
Pick proof protections



Candado con retención de llave



Tarjeta de propiedad  
Owner card



Kit de montaje de cilindros  
Cylinder assembling kit

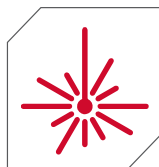

Servicio de grabado láser  
Laser engraving service



Apertura con huella digital  
Fingerprint opening



Producto con alarma  
Product with alarm



Producto en caja  
Boxed product



Producto en blister  
Blister packed product

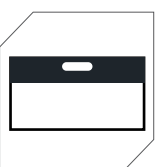

Producto en bolsa  
Bag packed product

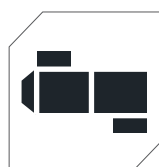

Producto en vitola de cartón  
Cardboard packed product



Pack 3 candados en llaves iguales  
3- keyed alike padlock pack



Nuevo producto en catálogo  
New product in the catalogue

## Abreviaturas - Abbreviations

Estos son los significados de las abreviaturas que se muestran en los encabezamientos de las tablas:

- Ref.: referencia del producto.
- Cod.: código de producto.
- Uni.: unidades de producto por caja.
- €/uni.: precio por unidad.
- Cl.: color/acabado del producto.
- Pack: embalaje del producto.
- IPL: IFAM Protection Level. Escala IFAM de niveles de seguridad. Grado máximo: 10
- ICR: IFAM Corrosion Resistance Level. Escala IFAM de resistencia a la corrosión. Grado máximo: 10

These are the meanings of the abbreviations shown in the headings of the tables:

- Ref.: product reference.
- Cod.: product code.
- Uni.: product units per box.
- €/unit: price per unit.
- Cl.: color / finish of the product.
- Pack: product packaging.
- IPL: IFAM Protection Level. Maximum grade: 10
- ICR: IFAM Corrosion Resistance Level. Maximum grade: 10

## Condiciones de venta - Sales conditions

### Devoluciones y reposiciones - Returns and replacements

- No se aceptará devolución alguna de material sin autorización previa por parte de IFAM Seguridad, S.L.U. Si procede la devolución, el transporte se deberá realizar a través de la empresa de transporte indicada por IFAM Seguridad, S.L.U.
- IFAM Seguridad, S.L.U. garantiza la calidad de sus productos. Ante posibles defectos de fabricación, IFAM Seguridad, S.L.U. se compromete a reponer el producto, no haciéndose cargo, en ningún caso, de cualquier otro tipo de gastos.
- Las mercancías pertenecen a IFAM Seguridad, S.L.U. hasta el pago total por parte del cliente de la factura correspondiente.
- No returns will be accepted without prior authorisation from IFAM Seguridad, S.L.U. If a return is warranted, the shipping shall be carried out using the shipping company indicated by IFAM Seguridad, S.L.U.
- IFAM Seguridad, S.L.U. guarantees the quality of its products. In case of any possible manufacturing defect, IFAM Seguridad, S.L.U. will replace the product, being not liable for any other expense.
- The goods belong to IFAM Seguridad, S.L.U. until the customer has paid the corresponding invoice in full.

### Modificaciones y recargos - Modifications and surcharges

- IFAM Seguridad, S.L.U. se reserva el derecho de descatalogar o modificar sus artículos cuando lo considere necesario.
- Los artículos que se ofrecen en surtido de colores pueden suministrarse por color específico con un recargo.
- Los candados pueden suministrarse con un marcado personalizado con un recargo.
- IFAM Seguridad, S.L.U. reserves the right to discontinue or modify its products when deemed necessary.
- The items offered in different colours can be supplied in a specific colour with a surcharge.
- Locks may be supplied with a personalised marking with a surcharge.







## CILINDROS CYLINDERS

**SERIE  
WX1000**  
WX1000  
SERIES



PÁG.  
10

**SERIE  
NK1000**  
NK1000  
SERIES



PÁG.  
13

**SERIE M+ (ANTI  
SNAP)**  
M+ (ANTI SNAP)  
SERIES



PÁG.  
14

**SERIE  
M/F6S**  
M/F6S  
SERIES



PÁG.  
16

**SERIE  
HUNO**  
HUNO  
SERIES



PÁG.  
19

**SERIE D**  
D SERIES



PÁG.  
20

**SERIE F5S**  
F5S SERIES



PÁG.  
22

**CILINDRO  
ELÉCTRICO**  
ELECTRIC  
CYLINDER



PÁG.  
24

**ACCESORIOS**  
ACCESSORIES



PÁG.  
25

## Serie WX1000 - WX1000 Series

- Cilindro perfil europeo de alta seguridad. Certificado según Norma EN:1303:2015.
- Perfil con diseño patentado por IFAM (nº 2.061.242).
- Cuerpo fabricado en latón extruido. Acabados en níquel y latón.
- 16 pitones activos y amaestrables, con millones de combinaciones.
- Triple protección antibumping. Incluye un innovador sistema con doble pitón y doble muelle.
- Puente reforzado antirrotura, fabricado en acero inoxidable y unido al cuerpo del cilindro por 4 pasadores de acero.
- Máxima protección antitaladro con barras en el rotor y el cuerpo, coraza en la zona inferior y pitones adicionales de acero.
- Protección antiganzúa.
- Sistema de doble embrague: permite abrir cuando una llave bloquea el lado opuesto.
- Se suministra con 5 llaves de alpaca con cabeza sobremoldeada en resina ABS para mayor comodidad de uso.
- Incluye tarjeta de propiedad con el sistema de seguridad CCS (Control Code System). Máximo nivel de seguridad, control y trazabilidad de la copia de llaves para el usuario.
- Llave compatible con cilindros Serie WX.
- Consultar disponibilidad para otras medidas y variantes.
- High security euro profile cylinder. Certified to EN:1303:2015.
- IFAM patented (no. 2.061.242) key profile
- Extruded brass body. Nickel or brass finish.
- 16 active pins, all of them able for master keying, with millions of differs.
- Triple anti-bumping protection. Innovative double pin and double spring system included.
- Reinforced anti-snap bar, made of stainless steel and attached to the body using four steel bolts.
- Maximum anti-drill protection. Hardened pins fitted inside the front of the body and around the keyway.
- Anti-pick protection.
- Emergency system included: the cylinder allows opening the door even when a key blocks the other side of the lock.
- Supplied with five nickel silver keys, with overmoulded head made from ABS resin for a more comfortable use.
- Property card included with CCS (Control Code System). This system provides the user the maximum security and control of key duplications.
- Key compatible with WX Series cylinders.
- Check availability for other dimensions and variations.

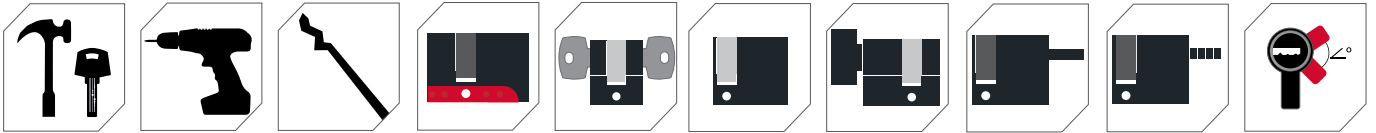

### PROTECCIÓN CONTRA LAS PRINCIPALES TENTATIVAS DE ROBO PROTECTION AGAINST THE MOST COMMON ROBBERY METHODS

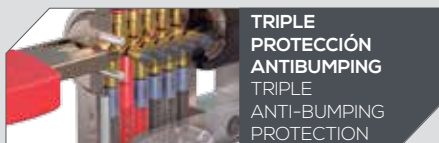

**TRIPLE  
PROTECCIÓN  
ANTIBUMPING**  
TRIPLE  
ANTI-BUMPING  
PROTECTION



**PROTECCIÓN  
ESPECIAL  
ANTITALADRO**  
SPECIAL  
ANTI-DRILL  
PROTECTION



**PUENTE  
REFORZADO  
ANTIRROTURA**  
REINFORCED  
ANTI-SNAP  
BAR

### PERFIL PATENTADO PATENTED PROFILE



El perfil patentado WX de IFAM le proporciona un extra de seguridad a su cilindro, en lo que al control de las copias de llave se refiere. Sólo IFAM y los profesionales autorizados por la marca pueden realizar copias de llave de los cilindros WX1000 y WX.

IFAM's WX patented profile provides extra security to your cylinder, when it comes to key duplications. Only IFAM and the professionals authorized by the brand can make key copies of the WX1000 and WX cylinders' keys.

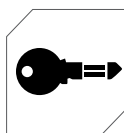
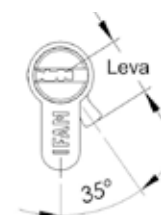
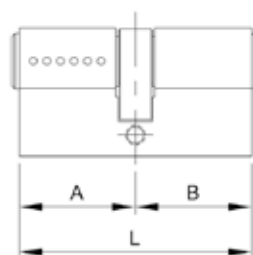

Cod. 900700

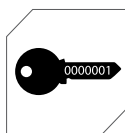

Cod. 900900



Cod. 901150

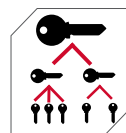

Cod. 901450

Ref.	Cod.	Cl.	L	A	B	Uni.
<b>LEVA CAM: 15mm. Pack.</b>						
1000WX1030L	060100	■	40	10	30	6
1000WX1030N	060110	■	40	10	30	6
1000WX3030L	060200	■	60	30	30	6
1000WX3030N	060210	■	60	30	30	6
1000WX3035L	060300	■	65	30	35	6
1000WX3035N	060310	■	65	30	35	6
1000WX3040L	060400	■	70	30	40	6
1000WX3040N	060410	■	70	30	40	6
1000WX3045L	060500	■	75	30	45	6
1000WX3045N	060510	■	75	30	45	6
1000WX3050L	060600	■	80	30	50	6
1000WX3050N	060610	■	80	30	50	6
1000WX3060L	060800	■	90	30	60	6
1000WX3060N	060810	■	90	30	60	6
1000WX3070N	060910	■	100	30	70	6
1000WX3535L	061000	■	70	35	35	6
1000WX3535N	061010	■	70	35	35	6
1000WX3540N	061110	■	75	35	40	6
1000WX3545N	061170	■	80	35	45	6
1000WX4040L	061400	■	80	40	40	6
1000WX4040N	061410	■	80	40	40	6
1000WX4050N	061610	■	90	40	50	6
1000WX4060N	061710	■	100	40	60	6
1000WX4545N	061810	■	90	45	45	6
1000WX5050N	061910	■	100	50	50	6

Ref.	Cod.	Cl.	L	A	B	Uni.
<b>LEVA CAM: 13mm. Pack.</b>						
1000WX3030LC	060250	■	60	30	30	6
1000WX3030NC	060260	■	60	30	30	6
1000WX3040LC	060450	■	70	30	40	6
1000WX3040NC	060460	■	70	30	40	6
1000WX3535LC	061050	■	70	35	35	6
1000WX3535NC	061060	■	70	35	35	6
1000WX4040LC	061450	■	80	40	40	6
1000WX4040NC	061460	■	80	40	40	6
<b>LEVA CAM: 15mm. Pack.</b>						
1000WX3030L	060201	■	60	30	30	6
1000WX3030N	060211	■	60	30	30	6
1000WX3040L	060401	■	70	30	40	6
1000WX3040N	060411	■	70	30	40	6
1000WX3535L	061001	■	70	35	35	6
1000WX3535N	061011	■	70	35	35	6
1000WX4040L	061401	■	80	40	40	6
1000WX4040N	061411	■	80	40	40	6

Ref.	Cod.	Cl.	L	A	B	Uni.
<b>LEVA CAM: 13mm. Pack.</b>						
1000WX3030LC	060251	■	60	30	30	6
1000WX3030NC	060261	■	60	30	30	6
1000WX3040LC	060451	■	70	30	40	6
1000WX3040NC	060461	■	70	30	40	6
1000WX3535LC	061051	■	70	35	35	6
1000WX3535NC	061061	■	70	35	35	6
1000WX4040LC	061451	■	80	40	40	6
1000WX4040NC	061461	■	80	40	40	6

Ver pag. siguiente / See next page

## Serie WX1000 - WX1000 Series

Ref.	Cod.	Cl.	L	A	B	Uni.
<b>POMO THUMB TURN. LEVA CAM: 15mm. Pack. </b>						
1000WXP3030L	060202		60	30	30	6
1000WXP3040L	060402		70	30	40	6
1000WXP3040N	060412		70	30	40	6
1000WXP3535L	061002		70	35	35	6
1000WXP3535N	061012		70	35	35	6
1000WXP4040L	061402		80	40	40	6
1000WXP4040N	061412		80	40	40	6
1000WXP3060N	060812		100	30	40	6
1000WXP3060L	060802		100	30	40	6
<b>POMO THUMB TURN. LEVA CAM: 13mm. Pack. </b>						
1000WXP3030LC	060252		60	30	30	6
1000WXP3030NC	060262		60	30	30	6
1000WXP3040LC	060452		70	30	40	6
1000WXP3040NC	060462		70	30	40	6
1000WXP3535LC	061052		70	35	35	6
1000WXP3535NC	061062		70	35	35	6
1000WXP4040LC	061452		80	40	40	6
1000WXP4040NC	061462		80	40	40	6

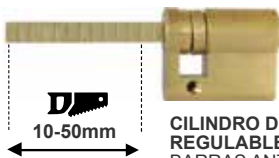

**CILINDRO DE LENGÜETA REGULABLE (PARA BARRAS ANTIPÁNICO)**  
**CYLINDER WITH ADJUSTABLE TAB (FOR ANTI-PANIC BARS)**

Ref.	Cod.	Cl.	L	A	B	Uni.
<b>LEVA CAM: 15mm. Pack. </b>						
1000WX1030LR	060108		40	10	30	1
1000WX1030NR	060118		40	10	30	1

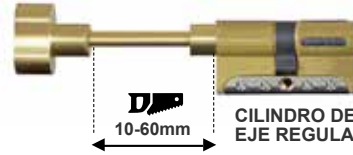

**CILINDRO DE EJE REGULABLE**  
**CYLINDER WITH ADJUSTABLE AXIS**

Ref.	Cod.	Cl.	L	A	B	Uni.
<b>LEVA CAM: 15mm. Pack. </b>						
1000WXE3030L	060206		60	30	30	1
1000WXE3030N	060216		60	30	30	1
1000WXE3035N	060316		65	30	35	1
1000WXE3040L	060406		70	30	40	1
1000WXE3040N	060416		70	30	40	1
1000WXE3045L	060506		75	30	45	1
1000WXE3045N	060516		75	30	45	1
1000WXE3050N	060616		80	30	50	1
1000WXE3060N	060716		90	30	60	1
1000WXE3070N	060816		100	30	70	1



**CILINDRO DE LEVA REGULABLE**  
**CYLINDER WITH ADJUSTABLE CAM**

Ref.	Cod.	Cl.	L	A	B	Uni.
<b>LEVA CAM: 15mm. Pack. </b>						
1000WX1030LA	060103		40	10	30	1
1000WX1030NA	060113		40	10	30	1



## Serie NK1000 - NK1000 Series

N

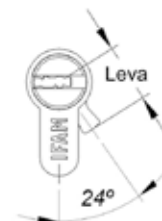
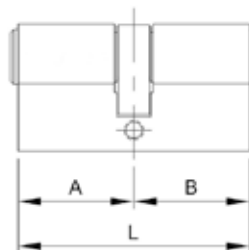

- Cilindro europerfil de alta seguridad con pitones y pasadores endurecidos antitaladro.
- Cilindro de llave estrecha, compatible con todos los escudos para puertas del mercado.
- Sistema de seguridad antiganzúa.
- 11 pitones de acero con miles de combinaciones
- Innovador sistema antibumping con doble pitón y doble muelle.
- Acabados en latón y níquel mate
- Incluye 5 llaves de seguridad.
- Incluye tarjeta de propiedad para el control de sus copias de llave.
- Consultar disponibilidad para otras medidas y variantes.

- High-security Euro profile cylinder with anti-drilling hardened pins and coters.
- Narrow key cylinder. Compatible with narrow neck door escutcheons.
- Anti-pick security system.
- 11 steel pins with thousands of combinations.
- Innovative anti-bumping system with double pins and double spring.
- Matte nickel and brass finishes.
- Includes 5 security dimple keys.
- Owner card included for controlling key duplications.
- Check availability for other dimensions and variations.

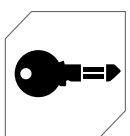

Cod. 900720

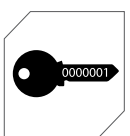

Cod. 900920



Cod. 901170



Cod. 901470

Ref.	Cod.	Cl.	L	A	B	Uni.
<b>LEVA CAM: 15mm. Pack. </b>						
1000NK3030L	078000		60	30	30	6
1000NK3030N	078010		60	30	30	6
1000NK3040L	078200		70	30	40	6
1000NK3040N	078210		70	30	40	6
1000NK3535L	078800		70	35	35	6
1000NK3535N	078810		70	35	35	6
1000NK3050L	078400		80	30	50	6
1000NK4040L	079200		80	40	40	6

## Serie M + (Anti Snap) / F6S+ \* - M + (Anti Snap) / F6S+ \* Series

El sistema anti snap le proporciona un extra de seguridad a su cerradura, al incorporar una línea de rotura programada por la que se fractura el cilindro cuando se intenta su extracción a la fuerza.

- Cilindro perfil europeo certificado según Norma EN:1303:2015.
- 2 pasadores antitaladro extra respecto a la Serie M.
- Sistema antibumping.
- Bombillo con sistema de seguridad antiganzúa.
- Dispone de 6 pitones endurecidos con miles de combinaciones.
- Muelles de acero inoxidable.
- Doble antisnap en medidas asimétricas (consultar disponibilidad).
- Se suministra con 5 llaves de puntos de seguridad.
- Llave compatible con: cilindros Serie M; candados Titán, Huno 80 y Armoured S; cerrojos CS88 M50/M70, CS88 LV y B6.
- Consultar disponibilidad para otras medidas y variantes.

(\*) En los meses siguientes a la publicación de este catálogo, la Serie M+ (Anti Snap) pasará a llamarse Serie F6S+.

The anti snap system reinforces your lock's security, thanks to the break point placed near the cylinder's edge. That is where the cylinder breaks when forced removal is attempted.

- European profile cylinder certified to EN:1303:2015.
- 2 extra drill resistant pins.
- Bump-proof protection.
- Tumbler cylinder with pick proof system.
- 6-pin row with thousands of differs.
- Stainless steel springs.
- Double anti snap system in offset sizes (check availability)
- Supplied with 5 security dimple keys.
- Key compatible with: M series cylinders, Titan, Huno 80 and Armoured S padlocks; CS88 M50/ M70, CS88LV and B6 rim locks.
- Check availability for other dimensions and variations.

(\*) In the months following the publication of this catalogue, the M+ (Anti Snap) Series will be renamed the F6S+ Series.

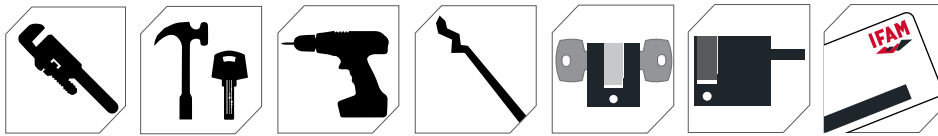

### SISTEMA ANTI SNAP ANTI SNAP SYSTEM

#### CON ANTI SNAP - WITH ANTI SNAP



Tomemos como ejemplo un cilindro que sobresale de la cerradura de la puerta.

Let's take, for example, a cylinder protruding from the door lock.



El cilindro queda expuesto a quienes pretendan extraerlo rompiéndolo por el exterior.

The cylinder is exposed to those who seek breaking it by removing from outside.



El sistema anti snap hace que el cilindro se rompa a la altura de la línea de rotura programada.

The anti snap system makes the cylinder split up by the break point.



Así, el resto del cuerpo del cilindro sigue intacto y funcionando.

This way, the rest of the cylinder body remains intact and functioning.

#### CON ANTI SNAP - WITH ANTI SNAP



Si el usuario introduce su llave, el cilindro funciona, mientras que los atacantes ya no pueden extraerlo por el rotor.

If the user enters the key, the cylinder operates, while attackers can no longer remove it.



Vista de las dos partes: el cuerpo, intacto en la cerradura, y el frontal del cilindro hasta la línea de rotura programada.

View of the two parts: the body, intact inside the lock, and the front part of the cylinder to the break point.

#### SIN ANTI SNAP - WITHOUT ANTI SNAP



Sin la protección de la línea de rotura programada, si el cilindro sobresale de la cerradura de la puerta...

Without the protection of break line, if the cylinder protrudes from the door lock...



... el cuerpo del cilindro se parte por el centro, facilitando el acceso del atacante.

... the cylinder body splits down the middle, facilitating access for attacker.

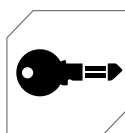
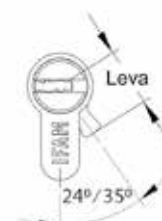
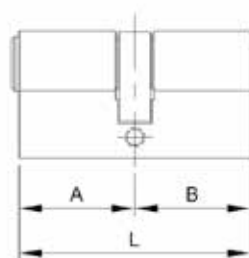

Cod. 900730

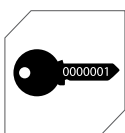

Cod. 900930



Cod. 901180



Cod. 901480



PAG. 108



Cod. 178120

Ref.	Cod.	Cl.	L	A	B	Uni.
<b>LEVA CAM: 15mm. Pack.</b>						
M1030SL	035004	■	40	10	30	12
M1030SN	035014	■	40	10	30	12
M1040SL	036204	■	50	10	40	12
M1040SN	036214	■	50	10	40	12
M3030SN	035214	■	60	30	30	12
M3030SL	035204	■	60	30	30	12
M3035SN	035314	■	65	30	35	12
M3035SL	035304	■	65	30	35	12
M3040SN	035414	■	70	30	40	12
M3040SL	035404	■	70	30	40	12
M3535SN	036014	■	70	35	35	12
M3535SL	036004	■	70	35	35	12
M3050SN	035614	■	80	30	50	12
M3050SL	035604	■	80	30	50	12
M4040SN	036414	■	80	40	40	12
M4040SL	036404	■	80	40	40	12

Ref.	Cod.	Cl.	L	A	B	Uni.
<b>LEVA CAM: 13mm. Pack.</b>						
M3030SNC	035264	■	60	30	30	12
M3030SLC	035254	■	60	30	30	12
M3040SNC	035464	■	70	30	40	12
M3040SLC	035454	■	70	30	40	12
M3535SNC	036064	■	70	35	35	12
M3535SLC	036054	■	70	35	35	12
M3050SNC	035664	■	80	30	50	12
M3050SLC	035654	■	80	30	50	12
M4040SNC	036464	■	80	40	40	12
M4040SLC	036454	■	80	40	40	12
<b>DOBLE EMBRAGUE. EMERGENCY SYSTEM</b>						
<b>LEVA CAM: 15mm Pack.</b>						
M3030SLD	035224	■	60	30	30	12
M3030SND	035234	■	60	30	30	12
M3035SLD	035324	■	65	30	35	12
M3035SND	035334	■	65	30	35	12

Ref.	Cod.	Cl.	L	A	B	Uni.
M3040SLD	035424	■	70	30	40	12
M3040SND	035434	■	70	30	40	12
M3045SLD	035524	■	75	30	45	12
M3045SND	035534	■	75	30	45	12
M3535SLD	036024	■	70	35	35	12
M3535SND	036034	■	70	35	35	12
M3050SLD	035624	■	80	30	50	12
M3050SND	035634	■	80	30	50	12
M3060SLD	035824	■	90	30	60	12
M3060SND	035834	■	90	30	60	12
M4040SLD	036424	■	80	40	40	12
M4040SND	036434	■	80	40	40	12

Ref.	Cod.	Cl.	L	A	B	Uni.
<b>DOBLE EMBRAGUE. EMERGENCY SYSTEM</b>						
<b>LEVA CAM: 13mm Pack.</b>						
M3030SLCD	035274	■	60	30	30	12
M3030SNCD	035284	■	60	30	30	12
M3035SLCD	035374	■	65	30	35	12
M3035SNCD	035384	■	65	30	35	12
M3040SNCD	035484	■	70	30	40	12
M3045SLCD	035574	■	75	30	45	12
M3045SNCD	035584	■	75	30	45	12
M3050SLCD	035674	■	80	30	50	12
M3050SNCD	035684	■	80	30	50	12
M3060SLCD	035874	■	90	30	60	12
M3060SNCD	035884	■	90	30	60	12
M3535SLCD	036074	■	70	35	35	12
M3535SNCD	036084	■	70	35	35	12
M4040SLCD	036474	■	80	40	40	12
M4040SNCD	036484	■	80	40	40	12



10-60mm

**CILINDRO DE EJE REGULABLE**  
CYLINDER WITH ADJUSTABLE AXIS

Ref.	Cod.	Cl.	L	A	B	Uni.
<b>LEVA CAM: 15mm. Pack.</b>						
ME3030SL	037306	■	60	30	30	12
ME3030SN	037326	■	60	30	30	12
ME3040SL	037336	■	70	30	40	12
ME3040SN	037356	■	70	30	40	12
ME3050SL	037366	■	80	30	50	12
ME3050SN	037386	■	80	30	50	12

## Serie M / F6S\* - M / F6S\* Series

- Cilindro perfil europeo certificado según Norma EN:1303:2015.
- Sistema antibumping y antiganzúa.
- 6 pitones con miles de combinaciones.
- Dispone de pitones endurecidos y pasadores antitaladro.
- Muelles de acero inoxidable.
- Acabados en latón y en níquel mate.
- Se suministra con 5 llaves de puntos de seguridad.
- Llave compatible con: cilindros Serie M+ (Anti snap); candados Titán, Huno 80 y Armoured S; cerrojos CS88 M50/M70, CS88 LV y B6.
- Disponible con sistema de doble embrague: el cilindro se puede abrir por ambos lados incluso cuando una llave bloquea el lado opuesto.
- Disponible en medio cilindro, cilindro con pomo, cilindro con ángulo de leva regulable y cilindro regulable para barras antipánico.
- Consultar disponibilidad para otras medidas y variantes.

(\*) En los meses siguientes a la publicación de este catálogo, la Serie M pasará a llamarse Serie F6S.

- European profile cylinder certified to EN:1303:2015.
- Bump-proof and pick-proof protection.
- 6 pins with thousands of differs.
- Hardened and drill resistant pins and cotters.
- Stainless steel springs.
- Brass and nickel finishes.
- Supplied with 5 security dimple keys.
- Key compatible with: M+(Anti Snap) Series cylinders; Titan, Huno 80 and Armoured S padlocks; CS88 M50/M70, CS88 LV and B6 rim locks.
- Emergency option available: the cylinder can be opened from both sides of the door even if a key is blocking the opposite end.
- Half cylinders, thumb-turn cylinders, adjustable cam angle cylinders for anti-panic bars and modular cylinders available.
- Check availability for other dimensions and variations.

(\*) In the months following the publication of this catalogue, the M Series will be renamed the F6S Series.



Ref.	Cod.	Cl.	L	A	B	Uni.
<b>LEVA CAM: 15mm. Pack. </b>						
M1030L	035000	■	40	10	30	12
M1030N	035010	■	40	10	30	12
M1040L	036200	■	50	10	40	12
M1040N	036210	■	50	10	40	12
M3030L	035200	■	60	30	30	12
M3030N	035210	■	60	30	30	12
M3035L	035300	■	65	30	35	12
M3035N	035310	■	65	30	35	12
M3040L	035400	■	70	30	40	12
M3040N	035410	■	70	30	40	12
M3535L	036000	■	70	35	35	12
M3535N	036010	■	70	35	35	12
M3045L	035500	■	75	30	45	12
M3045N	035510	■	75	30	45	12
M3540L	036100	■	75	35	40	12
M3540N	036110	■	75	35	40	12
M3050L	035600	■	80	30	50	12
M3050N	035610	■	80	30	50	12
M4040L	036400	■	80	40	40	12
M4040N	036410	■	80	40	40	12
M3545L	037100	■	80	35	45	12
M3545N	037110	■	80	35	45	12
M3550L	037200	■	85	35	50	12
M3550N	037210	■	85	35	50	12
M3060L	035800	■	90	30	60	12
M3060N	035810	■	90	30	60	12
M4050L	036600	■	90	40	50	12
M4050N	036610	■	90	40	50	12

Ref.	Cod.	Cl.	L	A	B	Uni.
M4545L	036800	■	90	45	45	12
M4545N	036810	■	90	45	45	12
M3070L	035900	■	100	30	70	12
M3070N	035910	■	100	30	70	12
M4060L	036700	■	100	40	60	12
M4060N	036710	■	100	40	60	12
M5050L	036900	■	100	50	50	12
M5050N	036910	■	100	50	50	12
M5060L	036970	■	110	50	60	6
M5060N	036980	■	110	50	60	6
M6060L	036990	■	120	60	60	6
M6060N	037000	■	120	60	60	6
<b>LEVA CAM: 13mm. Pack. </b>						
M1030LC	035050	■	40	10	30	12
M1030NC	035060	■	40	10	30	12
M1040LC	036250	■	50	10	40	12
M1040NC	036260	■	50	10	40	12
M3030LC	035250	■	60	30	30	12
M3030NC	035260	■	60	30	30	12
M3035LC	035350	■	65	30	35	12
M3035NC	035360	■	65	30	35	12
M3040LC	035450	■	70	30	40	12
M3040NC	035460	■	70	30	40	12
M3535LC	036050	■	70	35	35	12
M3535NC	036060	■	70	35	35	12
M3045LC	035550	■	75	30	45	12
M3045NC	035560	■	75	30	45	12
M3540LC	036150	■	75	35	40	12
M3540NC	036160	■	75	35	40	12

Ref.	Cod.	Cl.	L	A	B	Uni.
M3050LC	035650	■	80	30	50	12
M3050NC	035660	■	80	30	50	12
M4040LC	036450	■	80	40	40	12
M4040NC	036460	■	80	40	40	12
M3545LC	037150	■	80	35	45	12
M3545NC	037160	■	80	35	45	12
M3550LC	037250	■	85	35	50	12
M3550NC	037260	■	85	35	50	12
M3060LC	035850	■	90	30	60	12
M3060NC	035860	■	90	30	60	12
M4050LC	036650	■	90	40	50	12
M4050NC	036660	■	90	40	50	12
M4545LC	036850	■	90	45	45	12
M4545NC	036860	■	90	45	45	12
M3070LC	035950	■	100	30	70	12
M3070NC	035960	■	100	30	70	12
M4060LC	036750	■	100	40	60	12
M4060NC	036760	■	100	40	60	12
M5050LC	036950	■	100	50	50	12
M5050NC	036960	■	100	50	50	12
<b>LEVA CAM: 15mm. Pack. </b>						
M1030L	035001	■	40	10	30	5
M1030N	035011	■	40	10	30	5
M1040L	036201	■	50	10	40	5
M1040N	036211	■	50	10	40	5
M3030L	035201	■	60	30	30	5
M3030N	035211	■	60	30	30	5
M3035L	035301	■	65	30	35	5
M3035N	035311	■	65	30	35	5



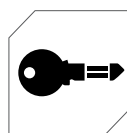
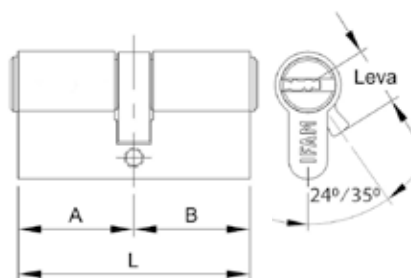

Cod. 900740

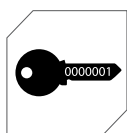

Cod. 900940



Cod. 901190



Cod. 901490



Cod. 178120



PAG.108

Ref.	Cod.	Cl.	L	A	B	Uni.
M3040L	035401	■	70	30	40	5
M3040N	035411	■	70	30	40	5
M3535L	036001	■	70	35	35	5
M3535N	036011	■	70	35	35	5
M3045L	035501	■	75	30	45	5
M3045N	035511	■	75	30	45	5
M3540L	036101	■	75	35	40	5
M3540N	036111	■	75	35	40	5
M3050L	035601	■	80	30	50	5
M3050N	035611	■	80	30	50	5
M4040L	036401	■	80	40	40	5
M4040N	036411	■	80	40	40	5
M3545L	037101	■	80	35	45	5
M3545N	037111	■	80	35	45	5
M3550L	037201	■	85	35	50	5
M3550N	037211	■	85	35	50	5
M3060L	035801	■	90	30	60	5
M3060N	035811	■	90	30	60	5
M4050L	036601	■	90	40	50	5
M4050N	036611	■	90	40	50	5
M4545L	036801	■	90	45	45	5
M4545N	036811	■	90	45	45	5

**LEVA CAM: 13mm Pack.**

M1030LC	035051	■	40	10	30	5
M1030NC	035061	■	40	10	30	5
M1040LC	036251	■	50	10	40	5
M1040NC	036261	■	50	10	40	5
M3030LC	035251	■	60	30	30	5
M3030NC	035261	■	60	30	30	5

Ref.	Cod.	Cl.	L	A	B	Uni.
M3035LC	035351	■	65	30	35	5
M3035NC	035361	■	65	30	35	5
M3040LC	035451	■	70	30	40	5
M3040NC	035461	■	70	30	40	5
M3535LC	036051	■	70	35	35	5
M3535NC	036061	■	70	35	35	5
M3045LC	035551	■	75	30	45	5
M3045NC	035561	■	75	30	45	5
M3540LC	036151	■	75	35	40	5
M3540NC	036161	■	75	35	40	5
M3050LC	035651	■	80	30	50	5
M3050NC	035661	■	80	30	50	5
M4040LC	036451	■	80	40	40	5
M4040NC	036461	■	80	40	40	5
M3545LC	037151	■	80	35	45	5
M3545NC	037161	■	80	35	45	5
M3550LC	037251	■	85	35	50	5
M3550NC	037261	■	85	35	50	5
M3060LC	035851	■	90	30	60	5
M3060NC	035861	■	90	30	60	5
M4050LC	036651	■	90	40	50	5
M4050NC	036661	■	90	40	50	5
M4545LC	036851	■	90	45	45	5
M4545NC	036861	■	90	45	45	5

**POMO THUMB TURN. LEVA CAM: 15mm. Pack.**

MP3030L	035202	■	60	30	30	6
MP3030N	035212	■	60	30	30	6
MP3040L	035402	■	70	30	40	6

Ref.	Cod.	Cl.	L	A	B	Uni.
MP3040N	035412	■	70	30	40	6
MP3535L	036002	■	70	35	35	6
MP3535N	036012	■	70	35	35	6
MP4030L	036302	■	70	40	30	6
MP4030N	036312	■	70	40	30	6
MP3050L	035602	■	80	30	50	6
MP3050N	035612	■	80	30	50	6
MP4040L	036402	■	80	40	40	6
MP4040N	036412	■	80	40	40	6
MP3060L	035802	■	90	30	60	6
MP3060N	035812	■	90	30	60	6

**POMO THUMB TURN. LEVA CAM: 13mm.**

**Pack.**

MP3030LC	035252	■	60	30	30	6
MP3030NC	035262	■	60	30	30	6
MP3040LC	035452	■	70	30	40	6
MP3040NC	035462	■	70	30	40	6
MP3535LC	036052	■	70	35	35	6
MP3535NC	036062	■	70	35	35	6
MP3050LC	035652	■	80	30	50	6
MP3050NC	035662	■	80	30	50	6
MP4040LC	036452	■	80	40	40	6
MP4040NC	036462	■	80	40	40	6

Más referencias en pag. siguiente  
See next page for more references

## Serie M / F6S\* - M / F6S\* Series

Viene de la página anterior  
Coming from previous page

Ref.	Cod.	Cl.	L	A	B	Uni.
<b>DOBLE EMBRAGUE. EMERGENCY SYSTEM</b>						
<b>LEVA CAM: 15mm Pack. </b>						
M3030LD	035220	■	60	30	30	1
M3030ND	035230	■	60	30	30	1
M3035LD	035320	■	65	30	35	1
M3035ND	035330	■	65	30	35	1
M3040LD	035420	■	70	30	40	1
M3040ND	035430	■	70	30	40	1
M3535LD	036020	■	70	35	35	1
M3535ND	036030	■	70	35	35	1
M3045LD	035520	■	75	30	45	1
M3045ND	035530	■	75	30	45	1
M3540LD	036120	■	75	35	40	1
M3540ND	036130	■	75	35	40	1
M3050LD	035620	■	80	30	50	1
M3050ND	035630	■	80	30	50	1
M3545LD	037120	■	80	35	45	1
M3545ND	037130	■	80	35	45	1
M4040LD	036420	■	80	40	40	1
M4040ND	036430	■	80	40	40	1
M3550LD	037220	■	85	35	50	1
M3550ND	037230	■	85	35	50	1
M3060LD	035820	■	90	30	60	1

Ref.	Cod.	Cl.	L	A	B	Uni.
M3060ND	035830	■	90	30	60	1
M4050LD	036620	■	90	40	50	1
M4050ND	036630	■	90	40	50	1
M4545LD	036820	■	90	45	45	1
M4545ND	036830	■	90	45	45	1
M3070LD	035920	■	100	30	70	1
M3070ND	035930	■	100	30	70	1
M4060LD	036720	■	100	40	60	1
M4060ND	036730	■	100	40	60	1
M5050LD	036920	■	100	50	50	1
M5050ND	036930	■	100	50	50	1
M5060LD	036986	■	110	50	60	1
M5060ND	036987	■	110	50	60	1
M6060LD	036996	■	120	60	60	1
M6060ND	037010	■	120	60	60	1
<b>DOBLE EMBRAGUE. EMERGENCY SYSTEM</b>						
<b>LEVA CAM: 13mm Pack. </b>						
M3030LCD	035270	■	60	30	30	1
M3030NCD	035280	■	60	30	30	1
M3035LCD	035370	■	65	30	35	1
M3035NCD	035380	■	65	30	35	1
M3040LCD	035470	■	70	30	40	1
M3040NCD	035480	■	70	30	40	1

Ref.	Cod.	Cl.	L	A	B	Uni.
M3535LCD	036070	■	70	35	35	1
M3535NCD	036080	■	70	35	35	1
M3045LCD	035570	■	75	30	45	1
M3045NCD	035580	■	75	30	45	1
M3540LCD	036170	■	75	35	40	1
M3540NCD	036180	■	75	35	40	1
M3050LCD	035670	■	80	30	50	1
M3050NCD	035680	■	80	30	50	1
M3545LCD	037170	■	80	35	45	1
M3545NCD	037180	■	80	35	45	1
M4040LCD	036470	■	80	40	40	1
M4040NCD	036480	■	80	40	40	1
M3550LCD	037270	■	85	35	50	1
M3550NCD	037280	■	85	35	50	1
M3060LCD	035870	■	90	30	60	1
M3060NCD	035880	■	90	30	60	1
M4050LCD	036670	■	90	40	50	1
M4050NCD	036680	■	90	40	50	1
M3070LCD	035970	■	100	30	70	1
M3070NCD	035980	■	100	30	70	1
M4060LCD	036770	■	100	40	60	1
M4060NCD	036780	■	100	40	60	1
M5050LCD	036966	■	100	50	50	1
M5050NCD	036967	■	100	50	50	1

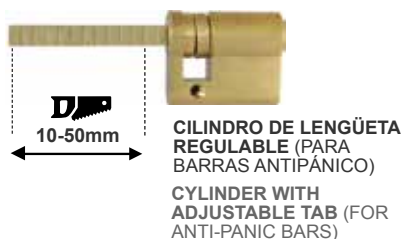
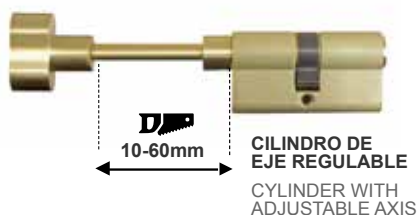

Ref.	Cod.	Cl.	L	A	B	Uni.
<b>LEVA CAM: 15mm. Pack. </b>						
ME3030L	035206	■	60	30	30	1
ME3030N	037316	■	60	30	30	1
ME3035L	035306	■	65	30	35	1
ME3035N	035316	■	65	30	35	1
ME3040L	035406	■	70	30	40	1
ME3040N	037346	■	70	30	40	1
ME3045L	035506	■	75	30	45	1
ME3045N	035516	■	75	30	45	1
ME3050L	035606	■	80	30	50	1
ME3050N	037376	■	80	30	50	1
ME3060L	035806	■	90	30	60	1
ME3060N	035816	■	90	30	60	1
ME3070L	035906	■	100	30	70	1
ME3070N	035916	■	100	30	70	1

Ref.	Cod.	Cl.	L	A	B	Uni.
<b>LEVA CAM: 15mm. Pack. </b>						
M1030LR	035008	■	40	10	30	1
M1030NR	035018	■	40	10	30	1
M1040LR	036208	■	50	10	40	1
M1040NR	036218	■	50	10	40	1

Ref.	Cod.	Cl.	L	A	B	Uni.
<b>LEVA CAM: 15mm. Pack. </b>						
M1030LA	035003	■	40	10	30	1
M1030NA	035013	■	40	10	30	1
M1040LA	036203	■	50	10	40	1
M1040NA	036213	■	50	10	40	1



## Serie Huno - Huno Series

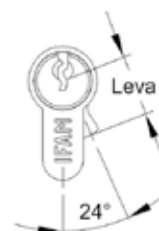
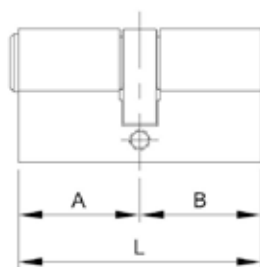

- Cilindro perfil europeo certificado según Norma EN:1303:2015.
- Llave con diseño protegido por IFAM.
- 5 pitones con miles de combinaciones.
- Pasadores antiganzúa y antitaladro.
- Muelles de acero inoxidable.
- Cuerpo de latón extruido.
- Acabado en níquel.
- Se suministra con 4 llaves patentadas de serreta con miles de combinaciones.
- Consultar disponibilidad para otras medidas y variantes.

- European profile cylinder certified to EN:1303:2015.
- Key protected design by IFAM.
- 5 pins with thousands of differs.
- Drill resistant and pick proof pins.
- Stainless steel springs.
- Extruded brass body.
- Nickel finish.
- Supplied with 4 patented standard keys with thousands of differs.
- Check availability for other dimensions and variations.

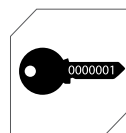
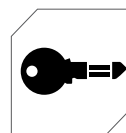
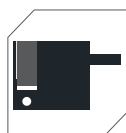
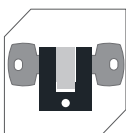
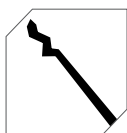

Cod. 900750 Cod. 900950



Cod. 901200

Cod. 901500

Cod. 178142

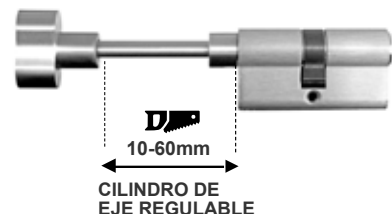

Ref.	Cod.	Cl.	L	A	B	Uni.
<b>LEVA CAM: 15mm. Pack.</b>						
HunoE3030N	001306	■	60	30	30	1
HunoE3040N	001316	■	70	30	40	1
HunoE3050N	001326	■	80	30	50	1



Ref.	Cod.	Cl.	L	A	B	Uni.
<b>LEVA CAM: 15mm. Pack.</b>						
Huno1030NR	001108	■	40	10	30	1
Huno1040NR	001118	■	50	10	40	1

Ref.	Cod.	Cl.	L	A	B	Uni.
<b>LEVA CAM: 15mm. Pack.</b>						
Huno1030N	001100	■	40	10	30	6
Huno1040N	001103	■	50	10	40	6
Huno3030N	001000	■	60	30	30	6
Huno3040N	001007	■	70	30	40	6
Huno3535N	001002	■	70	35	35	6
Huno3050N	001009	■	80	30	50	6
Huno4040N	001003	■	80	40	40	6
Huno4050N	001016	■	90	40	50	6
Huno5050N	001005	■	100	50	50	6
<b>POMO THUMB TURN. LEVA CAM: 15mm. Pack.</b>						
HunoP3030N	001200	■	60	30	30	6
HunoP3035N	001208	■	65	30	35	6
HunoP3040N	001210	■	70	30	40	6
HunoP3535N	001202	■	70	35	35	6
HunoP4030N	001209	■	70	40	30	6
HunoP3050N	001213	■	80	30	50	6
HunoP4040N	001203	■	80	40	40	6

## Serie D - D Series

- Cilindro perfil europeo certificado según Norma EN:1303:2015.
- Cuerpo y tambor de latón.
- 5 pitones con miles de combinaciones.
- Pasadores antitaladro.
- Muelles de acero inoxidable.
- Acabados en latón y en níquel mate.
- Se suministra con 3 llaves de serreta.
- Llave compatible con: candados K50, Inox50, Inox Cable, Max50, Armoured y Serie U; cerraduras CS125 y CS126.
- Consultar disponibilidad para otras medidas y variantes.

- European profile cylinder certified to EN:1303:2015.
- Brass body and barrel.
- 5 pins with thousands of differs.
- Drill resistant pins.
- Stainless steel springs.
- Brass and nickel finishes.
- Supplied with 3 standard keys.
- Key compatible with: K50, Inox50, Inox Cable, Max50, Armoured and U Series padlocks; CS125 and CS126 locks.
- Check availability for other dimensions and variations.



Ref.	Cod.	Cl.	A	B	L	Uni.
<b>LEVA CAM: 15mm. Pack.</b>						
D1030L	031000	■	40	10	30	12
D1030N	031010	■	40	10	30	12
D1040L	032600	■	50	10	40	12
D1040N	032610	■	50	10	40	12
D3030L	031300	■	60	30	30	12
D3030N	031310	■	60	30	30	12
D3040L	031600	■	70	30	40	12
D3040N	031610	■	70	30	40	12
D3535L	032300	■	70	35	35	12
D3535N	032310	■	70	35	35	12
D4040L	032900	■	80	40	40	12
D4040N	032910	■	80	40	40	12
D3050L	031900	■	80	30	50	12
D3050N	031910	■	80	30	50	12
D4050L	032966	■	90	40	50	12
D4050N	032969	■	90	40	50	12
D4545L	032972	■	90	45	45	12
D4545N	032975	■	90	45	45	12
D5050L	032978	■	100	50	50	12
D5050N	032981	■	100	50	50	12
<b>LEVA CAM: 13mm. Pack.</b>						
D1030LC	031050	■	40	10	30	12
D1030NC	031060	■	40	10	30	12
D1040LC	032650	■	50	10	40	12
D1040NC	032660	■	50	10	40	12
D3030LC	031350	■	60	30	30	12
D3030NC	031360	■	60	30	30	12
D3040LC	031650	■	70	30	40	12

Ref.	Cod.	Cl.	A	B	L	Uni.
D3040NC	031660	■	70	30	40	12
D3535LC	032350	■	70	35	35	12
D3535NC	032360	■	70	35	35	12
D4040LC	032950	■	80	40	40	12
D4040NC	032960	■	80	40	40	12
D3050LC	031950	■	80	30	50	12
D3050NC	031960	■	80	30	50	12
<b>LEVA CAM: 15mm. Pack.</b>						
D1030L	031001	■	40	10	30	5
D1030N	031011	■	40	10	30	5
D1040L	032601	■	50	10	40	5
D1040N	032611	■	50	10	40	5
D3030L	031301	■	60	30	30	5
D3030N	031311	■	60	30	30	5
D3040L	031601	■	70	30	40	5
D3040N	031611	■	70	30	40	5
D3535L	032301	■	70	35	35	5
D3535N	032311	■	70	35	35	5
D4040L	032901	■	80	40	40	5
D4040N	032911	■	80	40	40	5
D3050L	031901	■	80	30	50	5
<b>LEVA CAM: 13mm. Pack.</b>						
D1030LC	031051	■	40	10	30	5
D1030NC	031061	■	40	10	30	5
D1040LC	032651	■	50	10	40	5
D1040NC	032661	■	50	10	40	5
D3030LC	031351	■	60	30	30	5
D3030NC	031361	■	60	30	30	5
D3040LC	031651	■	70	30	40	5

Ref.	Cod.	Cl.	A	B	L	Uni.
D3040NC	031661	■	70	30	40	5
D3535LC	032351	■	70	35	35	5
D3535NC	032361	■	70	35	35	5
D4040LC	032951	■	80	40	40	5
D4040NC	032961	■	80	40	40	5
D3050LC	031951	■	80	30	50	5
<b>POMO THUMB TURN. LEVA CAM: 15mm. Pack.</b>						
DP3030L	031302	■	60	30	30	6
DP3030N	031312	■	60	30	30	6
DP3040L	031602	■	70	30	40	6
DP3040N	031612	■	70	30	40	6
DP3535L	032302	■	70	35	35	6
DP3535N	032312	■	70	35	35	6
DP4030L	032702	■	70	40	30	6
DP4030N	032712	■	70	40	30	6
DP3050L	031902	■	80	30	50	6
DP4040L	032902	■	80	40	40	6
DP4040N	032912	■	80	40	40	6
<b>POMO THUMB TURN. LEVA CAM: 13mm. Pack.</b>						
DP3030LC	031352	■	60	30	30	6
DP3030NC	031362	■	60	30	30	6
DP3040LC	031652	■	70	30	40	6
DP3040NC	031662	■	70	30	40	6
DP3535LC	032352	■	70	35	35	6
DP3535NC	032362	■	70	35	35	6
DP3050LC	031952	■	80	30	50	6
DP4040LC	032952	■	80	40	40	6
DP4040NC	032962	■	80	40	40	6

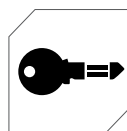
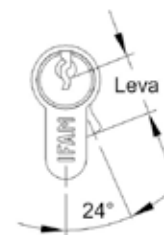
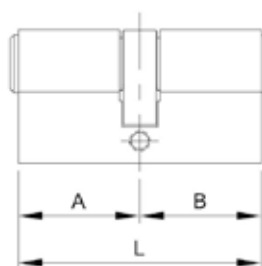

Cod. 900760

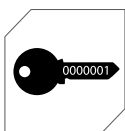

Cod. 900960



Cod. 901210



Cod. 901510



Cod. 178110



PAG. 108



10-60mm

CILINDRO DE EJE REGULABLE

CYLINDER WITH ADJUSTABLE AXIS



10-50mm

CILINDRO DE LENGÜETA REGULABLE (PARA BARRAS ANTIPÁNICO)

CYLINDER WITH ADJUSTABLE TAB (FOR ANTI-PANIC BARS)



CILINDRO DE LEVA REGULABLE

CYLINDER WITH ADJUSTABLE CAM

Ref.	Cod.	Cl.	L	A	B	Uni.
LEVA CAM: 15mm. Pack.						
DE3030L	031306		60	30	30	1
DE3030N	031316		60	30	30	1
DE3040L	031606		70	30	40	1
DE3040N	031616		70	30	40	1
DE3050L	031906		80	30	50	1
DE3050N	031916		80	30	50	1

Ref.	Cod.	Cl.	L	A	B	Uni.
LEVA CAM: 15mm. Pack.						
D1030LR	031008		40	10	30	1
D1030NR	031018		40	10	30	1
D1040LR	032608		50	10	40	1
D1040NR	032618		50	10	40	1

Ref.	Cod.	Cl.	L	A	B	Uni.
LEVA CAM: 15mm. Pack.						
D1030LA	031003		40	10	30	1
D1030NA	031013		40	10	30	1
D1040LA	031103		50	10	40	1
D1040NA	031113		50	10	40	1

## Serie F5S - F5S Series

- Cilindro perfil europeo.
- Cuerpo y tambor fabricados en latón extruido.
- 5 pitones con miles de combinaciones.
- Pitones antitaladro.
- Muelles en acero inoxidable.
- Acabados en níquel y latón.
- Se suministra con 3 llaves de serreta.
- Consultar disponibilidad para otras medidas y variantes.

- European profile cylinder.
- Brass body and barrel.
- 5 pins with thousands of differs.
- Drill resistant pins.
- Stainless steel springs.
- Brass and nickel finishes.
- Supplied with 3 standard keys.
- Check availability for other dimensions and variations.

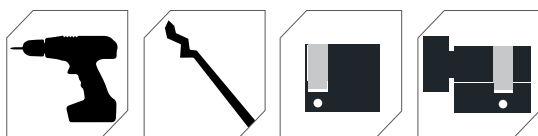

Ref.	Cod.	Cl.	L	A	B	Uni.
<b>LEVA CAM: 15mm. Pack.</b>						
F5S1030L	038000	■	40	10	30	6
F5S1030N	038020	■	40	10	30	6
F5S1035L	038040	■	45	10	35	6
F5S1035N	038060	■	45	10	35	6
F5S1040L	038080	■	50	10	40	6
F5S1040N	038100	■	50	10	40	6
F5S1045L	038120	■	55	10	45	6
F5S1045N	038140	■	55	10	45	6
F5S1050L	038160	■	60	10	50	6
F5S1050N	038180	■	60	10	50	6
F5S1055L	038200	■	65	10	55	6
F5S1055N	038220	■	65	10	55	6
F5S1060L	038240	■	70	10	60	6
F5S1060N	038260	■	70	10	60	6
F5S1070L	038280	■	80	10	70	6
F5S1070N	038300	■	80	10	70	6
F5S1080L	038320	■	90	10	80	6
F5S1080N	038340	■	90	10	80	6

Ref.	Cod.	Cl.	L	A	B	Uni.
F5S3030L	038360	■	60	30	30	6
F5S3030N	038380	■	60	30	30	6
F5S3035L	038400	■	65	30	35	6
F5S3035N	038420	■	65	30	35	6
F5S3040L	038460	■	70	30	40	6
F5S3040N	038480	■	70	30	40	6
F5S3045L	038500	■	75	30	45	6
F5S3045N	038520	■	75	30	45	6
F5S3050L	038540	■	80	30	50	6
F5S3050N	038560	■	80	30	50	6
F5S3055L	038580	■	85	30	55	6
F5S3055N	038600	■	85	30	55	6
F5S3060L	038620	■	90	30	60	6
F5S3060N	038640	■	90	30	60	6
F5S3070L	038660	■	100	30	70	6
F5S3070N	038680	■	100	30	70	6
F5S3080L	038700	■	110	30	80	6
F5S3080N	038720	■	110	30	80	6
F5S3090L	038740	■	120	30	90	6
F5S3090N	038760	■	120	30	90	6

Ref.	Cod.	Cl.	L	A	B	Uni.
F5S3535L	038780	■	70	35	35	6
F5S3535N	038800	■	70	35	35	6
F5S3540L	038820	■	75	35	40	6
F5S3540N	038840	■	75	35	40	6
F5S3545L	038860	■	80	35	45	6
F5S3545N	038880	■	80	35	45	6
F5S3550L	038900	■	85	35	50	6
F5S3550N	038920	■	85	35	50	6
F5S3555L	038940	■	90	35	55	6
F5S3555N	038960	■	90	35	55	6
F5S4040L	038980	■	80	40	40	6
F5S4040N	039000	■	80	40	40	6
F5S4045L	039020	■	85	40	45	6
F5S4045N	039040	■	85	40	45	6
F5S4050L	039060	■	90	40	50	6
F5S4050N	039080	■	90	40	50	6
F5S4060L	039100	■	100	40	60	6
F5S4060N	039120	■	100	40	60	6
F5S4545L	039140	■	90	45	45	6
F5S4545N	039160	■	90	45	45	6

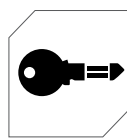
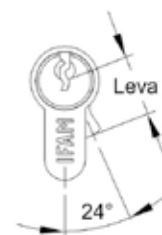
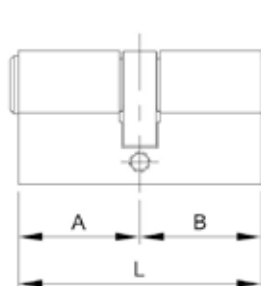

Cod. 900770

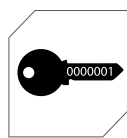

Cod. 900970



Cod. 901220

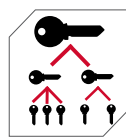

Cod. 901520



PAG. 108

Ref.	Cod.	Cl.	L	A	B	Uni.
F5S5050L	039180	■	100	50	50	6
F5S5050N	039200	■	100	50	50	6
F5S5060L	039220	■	110	50	60	6
F5S5060N	039240	■	110	50	60	6
<b>POMO THUMB TURN. LEVA CAM: 15mm.</b>						
<b>Pack. </b>						
F5SP1030L	038002	■	40	10	30	6
F5SP1040L	038082	■	40	10	40	6
F5SP1040N	038102	■	50	10	40	6
F5SP3030L	038362	■	60	30	30	6
F5SP3030N	038382	■	60	30	30	6
F5SP3040L	038462	■	70	30	40	6
F5SP3040N	038482	■	70	30	40	6
F5SP3050L	038542	■	80	30	50	6
F5SP3050N	038560	■	80	30	50	6
F5SP3060L	038622	■	90	30	60	6
F5SP3060N	038642	■	90	30	60	6
F5SP3535L	038782	■	70	35	35	6
F5SP3535N	038802	■	70	35	35	6

Ref.	Cod.	Cl.	L	A	B	Uni.
F5SP4040L	038982	■	80	40	40	6
F5SP4040N	039002	■	80	40	40	6
F5SP4050L	039062	■	90	40	50	6
F5SP4050N	039082	■	90	40	50	6
F5SP4060L	039102	■	100	40	60	6
F5SP4060N	039122	■	100	40	60	6
F5SP5050L	039182	■	100	50	50	6
F5SP5050N	039202	■	100	50	50	6
F5SP3530L	039302	■	65	35	30	6
F5SP3530N	039312	■	65	35	30	6
F5SP4030L	039322	■	70	40	30	6
F5SP4030N	039332	■	70	40	30	6
F5SP4535L	039342	■	80	45	35	6
F5SP4535N	039352	■	80	45	35	6
F5SP5040L	039362	■	90	50	40	6
F5SP5040N	039372	■	90	50	40	6
F5SP6030L	039382	■	90	60	30	6
F5SP6030N	039392	■	90	60	30	6
F5SP6040L	039402	■	100	60	40	6
F5SP6040N	039412	■	100	60	40	6

Ref.	Cod.	Cl.	L	A	B	Uni.
<b>LEVA CAM: 13mm. Pack. </b>						
F5S1030LC	038010	■	40	10	30	6
F5S1030NC	038030	■	40	10	30	6
F5S3030LC	038370	■	60	30	30	6
F5S3030NC	038390	■	60	30	30	6
F5S3035LC	038410	■	65	30	35	6
F5S3035NC	038430	■	65	30	35	6
F5S3040LC	038470	■	70	30	40	6
F5S3040NC	038490	■	70	30	40	6
F5S3535LC	038790	■	70	35	35	6
F5S3050LC	038550	■	70	35	35	6
F5S3050NC	038570	■	80	30	50	6
F5S4040LC	038990	■	80	40	40	6
F5S4040NC	039010	■	80	40	40	6

## Cilindro eléctrico M27x45 - M27x45 electric cylinder



- Adecuado para su uso en ascensores de accesos a viviendas y garajes comunitarios.
  - Válido para las series de cilindros WX1000, y M de IFAM.
  - Micro interruptor de émbolo.
  - Cuerpo y componentes en latón y muelles de acero inoxidable.
- 
- Suitable for use in access lifts to community dwellings and garages.
  - Suitable for IFAM's WX1000 and M Series cylinders.
  - Micro plunger switch.
  - Body and components in brass and stainless steel springs.

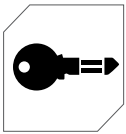
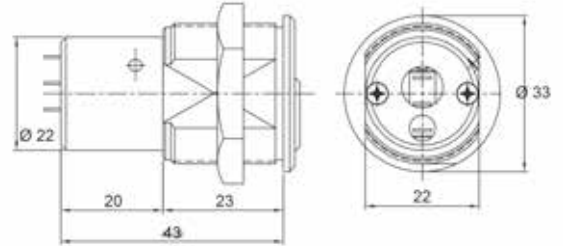

Cod. 900780

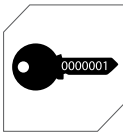

Cod. 900980



Cod. 901230



Cod. 901530



PAG. 108

Ref.	Cod.	Cl.	Uni.
1000WX 27x45	040134	■	3
M 27x45	040130	■	3





## Accesorios cilindros - Accessories for cylinders

	Ref.	Cod.
	Eje para cilindro pomo longitud regulable Brass thumb turn for cylinders	470698
	Pomo latón para cilindros Brass thumb turn for cylinders	470700
	Pomo níquel para cilindros Nickel thumb turn for cylinders	470710
	Tornillo para pomo Screw for thumb turn	470740
	Bola para pomo Ball for thumb turn	470745
	Caja eléctrica embutir Embedded electric lock	040160
	Caja eléctrica sobreponer Overlapping electric lock	040150
	Tornillo M5x40 M5x40 screw	437625
	Tornillo M5x50 M5x50 screw	437626
	Tornillo M5x60 M5x60 screw	437620
	Tornillo M5x70 M5x70 screw	437627

	Ref.	Cod.
	Tornillo M5x80 M5x80 screw	437628
	Kit montaje serie M / M+ Anti Snap M / M+ (Anti Snap) Series assembling kit	178120
	Kit montaje serie Huno Huno Series assembling kit	178142
	Kit montaje serie D D Series assembling kit	178110
	Leva corta M / D / F5S / Huno Short cam M / D / F5S / Huno	462360
	Leva corta WX1000 / M (doble embrague) Short cam WX1000 / M (emergency system)	462351
	Leva Larga M / D / F5S / Huno Standard DIN cam M / D / F5S / Huno	462361
	Leva larga WX1000 / M (doble embrague) Standard DIN cam WX1000 / M (emergency system)	462350
	Anilla retención D / M / WX1000 / NK1000 / F5S / Huno Retention ring D / M / WX1000 / NK1000 / F5S / Huno	462375
	Presilla de montaje Assembling clip	178810





## CERROJOS, CERRADURAS Y ESCUDOS RIM LOCKS, LOCKS & SCUTCHEONS

**CERROJOS**  
RIM LOCKS



PAG. 28

**CERRADURAS DE  
EMBURIR**  
MORTISE  
LOCKS



PAG. 33

**PICAPORTES**  
LATCHES



PAG. 35

**CERRADURAS DE  
LENGÜETA**  
CAM-LOCKS



PAG. 36

**ESCUDOS**  
ESCUTCHEONS



PAG. 37

**ACCESORIOS**  
ACCESSORIES



PAG. 41

### CS88



- Palanca de acero cuadrado de 17 mm.
- Condena de palanca desde el interior.  
Esta opción es desactivable si el cliente lo especifica en su pedido.
- Utilizable para puertas de apertura izquierda o derecha.
- Acabado latonado y cromo satinado.

- 17mm steel square handle.
- Handle seal from inside; this option can be deactivated under customer's request.
- Can be used on left-hand and right-hand doors.
- Brass and polished nickel plated finish.

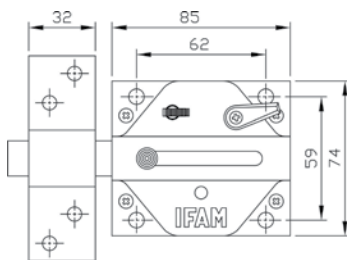

### CS88M50 / CS88 M70

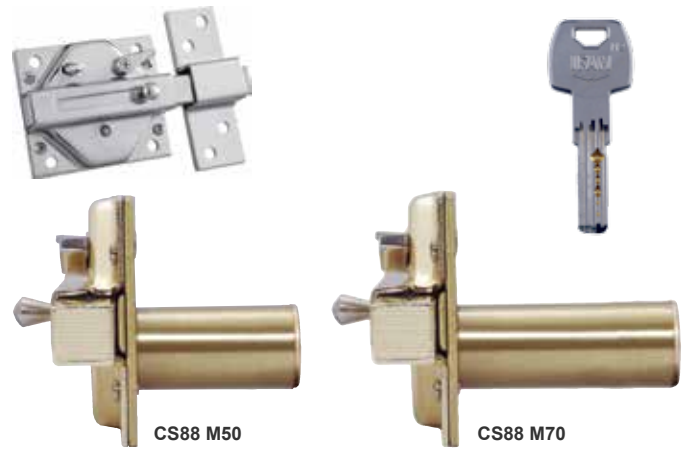

- Palanca de acero cuadrado de 17 mm.
- Condena de palanca desde el interior.  
Esta opción es desactivable si el cliente lo especifica en su pedido.
- Incluye cilindro. Dos opciones: 50 mm. ó 70 mm. de largo.
- Utilizable para puertas de apertura izquierda o derecha.
- Acabado latonado y cromo satinado.
- Llave compatible con: cilindros Serie M+ (Anti snap) y Serie M; candados Titán, Huno 80 y Armoured S; cerrojos CS88LV y B6.

- 17mm steel square handle.
- Handle seal from inside; this option can be deactivated under customer's request.
- Cylinder included. Two options: 50mm or 70mm long.
- Can be used on left-hand and right-hand doors.
- Brass and polished nickel plated finish.
- Key compatible with: M+ (Anti Snap) Series and M Series cylinders, Titan and Huno 80 padlocks and CS88LV and B6 rim locks.

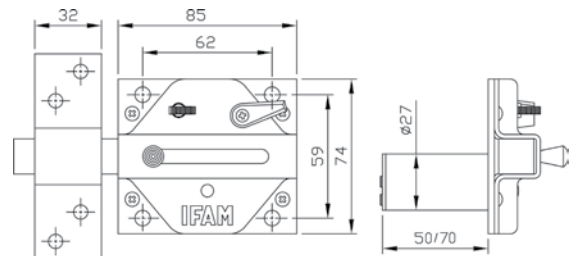
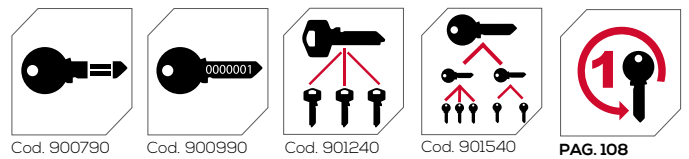

Ref.	CL.	Cod.	IPL	Pack	Uni.
CS88L	■	025202	6		1
CS88SC	■	025232	6		1

Ref.	CL.	Cod.	IPL	Pack	Uni.
CS88L M50	■	025206	8		1
CS88SC M50	■	025236	8		1
CS88L M70	■	025208	8		1
CS88SC M70	■	025238	8		1

## CS88LV



- Combina el cerrojo CS88 con escudo de alta seguridad en acero macizo de gran espesor.
- Cilindro de 11 pitones activos.
- Sistema antibumping.
- Conjunto antitaladro, antiextracción y antimordaza.
- Regulable para espesores de puerta de entre 30 y 80 mm.
- Suministrado con 5 llaves de puntos de seguridad.
- Llave compatible con: cilindros Serie M+ (Anti snap) y Serie M; candados Titán, Huno 80 y Armoured S; cerrojos CS88 y B6.
- It combines the CS88 rim lock with a very high security solid steel escutcheon.
- 11-active pin cylinder.
- Anti bumping system.
- Anti-extraction, drill resistant and pull resistant.
- Adjustable for door thickness between 35 and 55mm.
- Key compatible with: M+ (Anti Snap) Series and M Series cylinders, Titan, Huno 80 and Armoured S padlocks and CS88 and B6 rim locks.

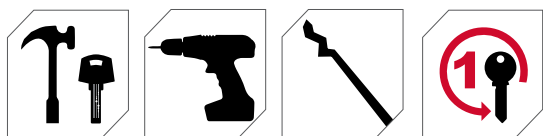

PAG.108

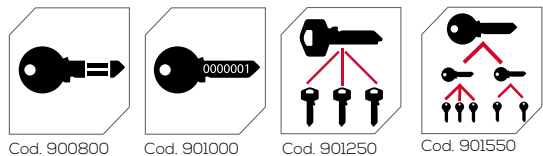

Cod. 900800

Cod. 901000

Cod. 901250

Cod. 901550

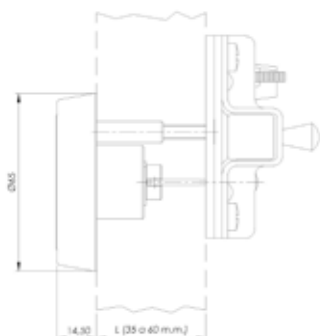

Ref.	CL.	Cod.	IPL	Pack	Uni.
CS88L LV	■	025213	10		1
CS88SC LV	■	025243	10		1

## CS200



\* Cilindro no incluido  
Supplied without cylinder

- Cerrojo diseñado para la instalación de cualquier cilindro europerfil.
- La propia leva del cilindro acciona la palanca del cerrojo. No es necesario cambiar la leva del cilindro por una leva de corona.
- Cuerpo fabricado en acero.
- Acabados en níquel y latón, con una alta resistencia al desgaste y la corrosión.
- Compatible con escudos con distancia entre ejes de 26 ó 38 mm., como todos los disponibles en la gama IFAM.
- Para saber la longitud del cilindro que necesita instalar con el cerrojo CS200 en su puerta, realice la siguiente suma: 30 mm (el cilindro que instale deberá tener 30mm. de largo en uno de sus extremos)+ 10 mm + espesor de su puerta en milímetros
- Incluye placa de montaje para escudos.
- Rim lock designed for installing any euro profile cylinder
- The cylinder cam activates the deadbolt lever directly, so there is no need to be replaced with a crown-shaped cam.
- Steel body.
- Brass and nickel finishes, highly resistant to wear and corrosion.
- Compatible with door escutcheons with a distance between axes of 26 or 38 mm, like the ones in the IFAM range.
- In order to know the length of the cylinder you have to instal in the CS200 rim lock, please make the following sum: 30 mm + 10 mm + the door's thickness in millimetres.
- Supplied with a plate for adding a door escutcheon.

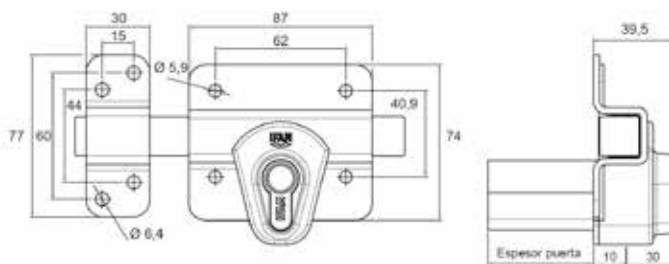

Ref.	CL.	Cod.	IPL	Pack	Uni.
CS200L	■	025310			1
CS200C	■	025320			1

## B6



- Cuerpo y cerradero de acero. Acabado en pintura epoxy.
- Muelle de acero inoxidable.
- Cilindro para llave de puntos de 6 pitones, Ø 23 mm. y longitudes 40, 45 y 50 mm.
- Palanca de acero cromado de 110 mm. y 2 vueltas.
- Utilizable para puertas de apertura izquierda o derecha.
- Se suministra con 5 llaves de puntos de seguridad.
- Llave compatible con: cilindros Serie M+ (Anti snap) y Serie M; candados Titán, Huno 80, Armoured S; cerrojos CS88 M50 / M70 y CS88LV.
- Accesorios disponibles: cerraderos para puertas metálicas y de madera; palancas de 160mm y 200 mm. Ver página 41.
- Steel body and strike. Epoxy paint finish.
- Stainless steel spring.
- 6 pin dimple cylinder, Ø 23 mm. Lengths: 40, 45 and 50mm.
- Chrome plated bolt measuring 110 mm. Double throw.
- Suitable for left-hand and right-hand doors.
- Supplied with 5 security dimple keys.
- Key compatible with: M+ (Anti Snap) Series and M Series cylinders, Titan, Huno 80 and Armoured S padlocks and CS88LV and CS88 rim locks.
- Available accessories: strikes for wooden or metal doors; 160mm and 200mm long bolts. See page 41.

## B5



- Cuerpo y cerradero de acero. Acabado en pintura epoxy.
- Muelle de acero inoxidable.
- Cilindro de 5 pitones, Ø23 mm. y longitudes de 30 a 60 mm.
- Palanca de acero cromado de 110 mm. y 2 vueltas.
- Utilizable para puertas de apertura izquierda o derecha.
- Se suministra con 3 llaves.
- Llave compatible con: cilindros Serie F5S y cerrojo D5.
- Accesorios disponibles: kit alargamiento de cilindro de 40mm, cerraderos para puertas metálicas y de madera; palancas de 160mm y 200 mm. Ver página 41.
- Steel body and strike. Epoxy paint finish.
- Stainless steel spring.
- 5 pin cylinder. Ø23 mm. Lengths from 30mm to 60mm.
- Chrome plated bolt measuring 110 mm. Double throw.
- Can be used on left-hand and right-hand doors.
- Supplied with 3 keys.
- Key compatible with: F5S Series cylinders and D5 rim lock.
- Available accessories: strikes for wooden or metal doors; 160mm and 200mm long bolts. See page 41.

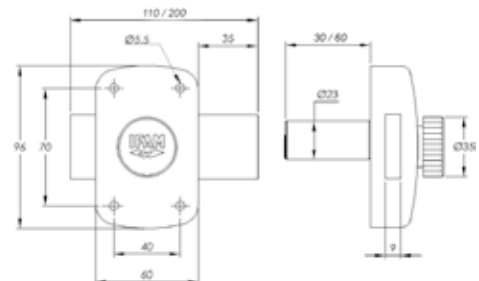
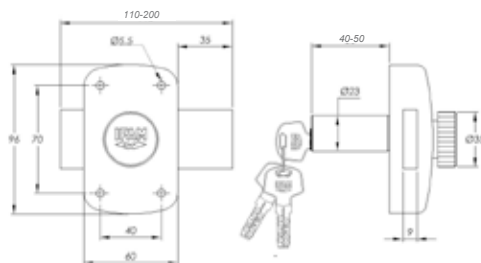
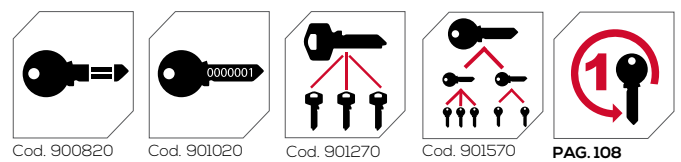
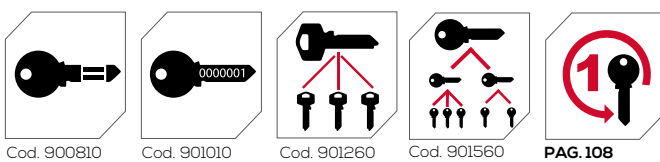

Ref.	Cod.	IPL		Pack	Uni.
B6/40	025356	8			1
B6/45	025358	8			1
B6/50	025360	8			1

Ref.	Cod.	IPL		Pack	Uni.
B5/30	025342F	7			1
B5/35	025344F	7			1
B5/40	025346F	7			1
B5/45	025348F	7			1
B5/50	025350F	7			1
B5/60	025352F	7			1

## D5

N



- Cerrojo con apertura con llave a ambos lados de la puerta.
- Cuerpo y cerradero de acero. Acabado en pintura epoxy.
- Muelle de acero inoxidable.
- Cilindro de 5 pitones, Ø 23 mm. y longitudes de 30 a 60 mm.
- Palanca de acero cromado de 110 mm. y 2 vueltas.
- Utilizable para puertas de apertura izquierda o derecha.
- Se suministra con 3 llaves.
- Llave compatible con: cilindros Serie F5S y cerrojo B5.
- Accesorios disponibles: kit alargamiento de cilindro de 40mm, cerraderos para puertas metálicas y de madera; palancas de 160mm y 200 mm. Ver página 41.

- Rim lock operated with key on both sides of the door.
- Steel body and strike. Epoxy paint finish.
- Stainless steel spring.
- 5 pin cylinder. Ø23 mm. Lengths from 30mm to 60mm.
- Chrome plated bolt measuring 110 mm. Double throw.
- Can be used on left-hand and right-hand doors.
- Supplied with 3 keys.
- Key compatible with: F5S Series cylinders and D5 rim lock.
- Available accessories: strikes for wooden or metal doors; 160mm and 200mm long bolts. See page 21.

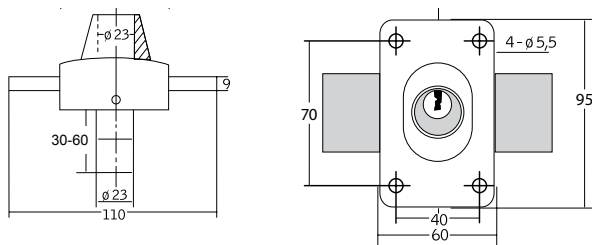
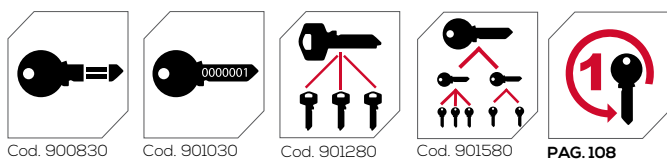

Ref.	Cod.	IPL		Pack	Uni.
D5/30	025370F	7			1
D5/35	025372F	7			1
D5/40	025374F	7			1
D5/45	025376F	7			1
D5/50	025378F	7			1
D5/60	025380F	7			1

## X5



- Cerrojo de seguridad.
- Adaptable a cualquier cilindro europerfil standard.
- Cuerpo y cerradero de acero. Acabado en pintura epoxy.
- Palanca en aleación de zinc de 110 mm. Dos vueltas.
- Utilizable para puertas de apertura izquierda o derecha.
- Ideal para puertas que requieran cambiar el cilindro frecuentemente.
- Compatible con la mayoría de cilindros europerfil del mercado.
- Cilindro no incluido.

- Security rim lock.
- Suitable for any Euro-profile cylinder.
- Steel body and strike. Epoxy paint finish.
- 110 mm zinc alloy bolt .Double throw.
- Suitable for left-hand or right-hand doors.
- Ideal for doors that require changing the cylinder frequently.
- Compatible with most of the Euro-profile cylinders on the market.
- Cylinder not included.

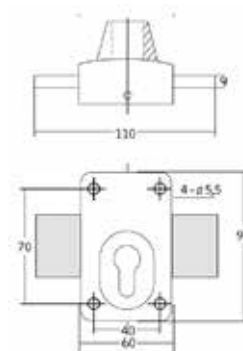

Ref.	Cl.	Cod.	Pack	Uni.
X5		026000		1
X5		026003		1

## CS126



- Cerradura de sobreponer apertura con llave por ambos lados.
- Picaporte, palanca y tirador de zamak.
- Cuerpo y cerradero de acero con pintura epoxy.
- Cilindro exterior de latón de 5 pitones.
- Suministrado con 3 llaves de serreta.
- Llave compatible con: cilindros D, candados K50, Max50, Inox50, Cable Inox, Serie U y Serie Armoured; cerradura CS125.
- Rim lock with key opening on both sides.
- Bolt, lever and latch made of zamak.
- Body and strike made of epoxy painted steel.
- Exterior cylinder made of brass with 5 pins.
- Supplied with 3 standard keys.
- Key compatible with: D cylinders, K50, Max50, Inox50, Inox Cable, U Series and Armoured Series padlocks; CS125 lock.

## CS125



- Cerradura de sobreponer apertura con apertura con pomo desde el interior.
- Picaporte, palanca y tirador de zamak.
- Cuerpo y cerradero de acero con pintura epoxy.
- Cilindro exterior de latón de 5 pitones.
- Suministrado con 3 llaves de serreta.
- Llave compatible con: cilindros D, candados K50, Max50, Inox50, Cable Inox, Serie U y Serie Armoured; cerradura CS126.
- Rim lock with latch operating handle for easy opening.
- Bolt, lever and latch made of zamak.
- Body and strike made of epoxy painted steel.
- Exterior cylinder made of brass with 5 pins.
- Supplied with 3 standard keys.
- Key compatible with: D cylinders, K50, Max50, Inox50, Inox Cable, U Series and Armoured Series padlocks; CS126 lock.

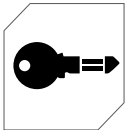

Cod. 900850

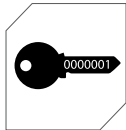

Cod. 901050



PAG. 108

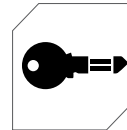

Cod. 900840

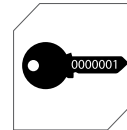

Cod. 901040



PAG. 108

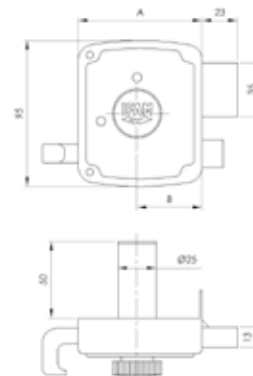

Ref.	Cod.	IPL	A	B		Pack	Uni.
CS126/80D	025718	7	80	42			1
CS126/80I	025725	7	80	42			1
CS126/100D	025736	7	100	50			1
CS126/100I	025742	7	100	50			1

Ref.	Cod.	IPL	A	B		Pack	Uni.
CS125/80D	025610	7	80	42			1
CS125/80I	025614	7	80	42			1
CS125/100D	025620	7	100	50			1
CS126/100I	025624	7	100	50			1



## Cerradura W900B / W900B Lock

- Cerradura de embutir para puertas de madera.
- Alto nivel de seguridad.
- Cierre con picaporte y 4 bulones.
- Distancia entre ejes de 85 mm.  
Entrada de 50mm.  
Nueca de 8 mm.
- Frente cuadrado o redondo.
- Acabado latonado o niquelado.
- Picaporte reversible.

- Mortice lock for wooden doors.
- High security level.
- Lock with latch and 4 bolts.
- 85mm lock centre,  
50mm backset and 8mm spindle.
- Square or round shaped front.
- Brass or nickel plated finish.
- Reversible latch.



Escudo ES803  
ES803 escutcheon



Cilindro M3535 + 5 llaves  
M3535 cylinder + 5 keys



Ref.	Code	Entrada Backset	Frente Plate	Cilindro Cylinder	IPL	Uni.
W900B 50CHL	W900B.50CHL	50	■	X	8	20
W900B 50RHL	W900B.50RHL	50	●	X	8	20
W900B 50CHN	W900B.50CHN	50	□	X	8	20
W900B 50RHN	W900B.50RHN	50	○	X	8	20
W900B 50CHLS	W900B.50CHLS	50	■		8	20
W900B 50RHLS	W900B.50RHLS	50	●		8	20
W900B 50CHNS	W900B.50CHNS	50	□		8	20
W900B 50RHNS	W900B.50RHNS	50	○		8	20
Cerradero W900B CHN	W900B.C.CHN		□			20
Cerradero W900B RHL	W900B.C.RHL		●			20
Cerradero W900B RHN	W900B.C.RHN		○			20
Cerradero W900B CHL	W900B.C.CHL		■			20
Frente W900B CHN	W900B.F.CHN		□			20
Frente W900B RHL	W900B.F.RHL		●			20
Frente W900B RHN	W900B.F.RHN		○			20
Frente W900B CHL	W900B.F.CHL		■			20

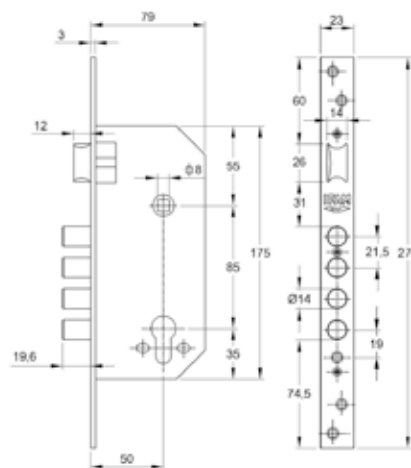

## Cerradura W500 / W500 Lock



- Cerradura de embutir para puertas de madera.
- Cierre monopunto y picaporte.
- Distancia entre ejes de 85 mm.  
Entrada de 50mm.  
Nueca de 8 mm.
- Frente cuadrado o redondo.
- Acabado latonado o niquelado.
- Picaporte reversible.

- Mortice lock for wooden doors.
- Reversible latch, deadbolt and euro profile cylinder.
- 85mm lock centre and 8mm spindle.  
Backset available in 40, 50 or 60 mm.
- Square or round shaped front.
- Brass or nickel plated finish.



Escudo ES803  
ES803 escutcheon



Cilindro C3030 + 3 llaves  
C3030 cylinder + 3 keys

Ref.	Code	Entrada Backset	Frente Plate	Cilindro Cylinder	IPL	Uni.
W500 40CHL	W500.40CHL	40	■	X	7	1
W500 40RHL	W500.40RHL	40	●	X	7	1
W500 40CHN	W500.40CHN	40	□	X	7	1
W500 40RHN	W500.40RHN	40	○	X	7	1
W500 50CHL	W500.50CHL	50	■	X	7	1
W500 50RHL	W500.50RHL	50	●	X	7	1
W500 50CHN	W500.50CHN	50	□	X	7	1
W500 50RHN	W500.50RHN	50	○	X	7	1
W500 60CHL	W500.60CHL	60	■	X	7	1
W500 60RHL	W500.60RHL	60	●	X	7	1
W500 60CHN	W500.60CHN	60	□	X	7	1
W500 60RHN	W500.60RHN	60	○	X	7	1
Cerradero W500 CHN	W500.C.CHN		□			50
Cerradero W500 RHL	W500.C.RHL		●			50
Cerradero W500 RHN	W500.C.RHN		○			50
Cerradero W500 CHL	W500.C.CHL		■			50
Frente W500 CHN	W500.F.CHN		□			35
Frente W500 RHL	W500.F.RHL		●			35
Frente W500 RHN	W500.F.RHN		○			35
Frente W500 CHL	W500.F.CHL		■			35

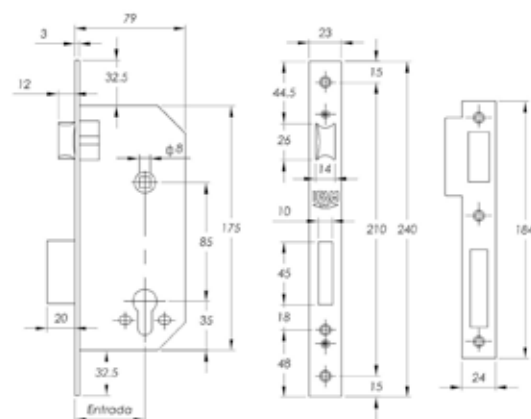

## Cerradura W400 - W400 Lock

- Cerradura de embutir para puertas de madera.
- Picaporte reversible, palanca y cilindro europerfil.
- Distancia entre ejes de 47 mm.  
Entrada de 50 mm. Nueca de 8 mm.
- Frente cuadrado.
- Acabado latonado.

- Mortice lock for wooden doors.
- Reversible latch, deadbolt and euro profile cylinder.
- 47mm centres, 50mm backset and 8mm spindle.
- Square front.
- Brass plated finish.



Cilindro C3030 + 3 llaves  
C3030 cylinder + 3 keys

Ref.	Code	Entrada Backset	Frente Plate	Cilindro Cylinder	IPL	Uni.
W400 50CHL	W400.50CHL	50		X	7	1

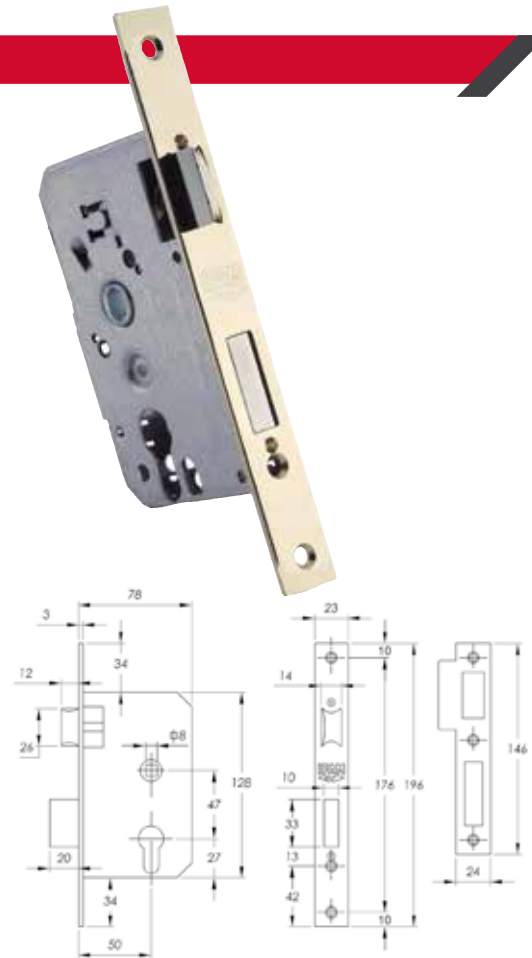

## Picaporte W170 - W170 Latch

- Picaporte para puertas de madera, con condena.
- Desbloqueo automático de condena (la condena con puerta abierta se desactiva al cerrarla).
- Distancia entre ejes de 70 mm. Entrada de 50mm.  
Nueca de 8 mm. Nueca de condena de 6 mm.
- Picaporte silencioso y reversible.
- Frente redondo.
- Acabado latonado o niquelado.
- Ideal para puertas de paso o condena.

- Dead locking latch for wooden doors.
- Automatic unlocking (locked when the door is open, deactivated when closed).
- Dimensions: 70mm centres, 50mm backset, 8mm spindle and 6mm locking spindle.
- Reversible latch.
- Round front.
- Brass or nickel plated finish.
- Ideal for inside doors or with handle lock.

Ref.	Code	Entrada Backset	Frente Plate	IPL	Uni.
W170 RHL	W170.RHL	50		6	1
W170 RHN	W170.RHN	50		6	1

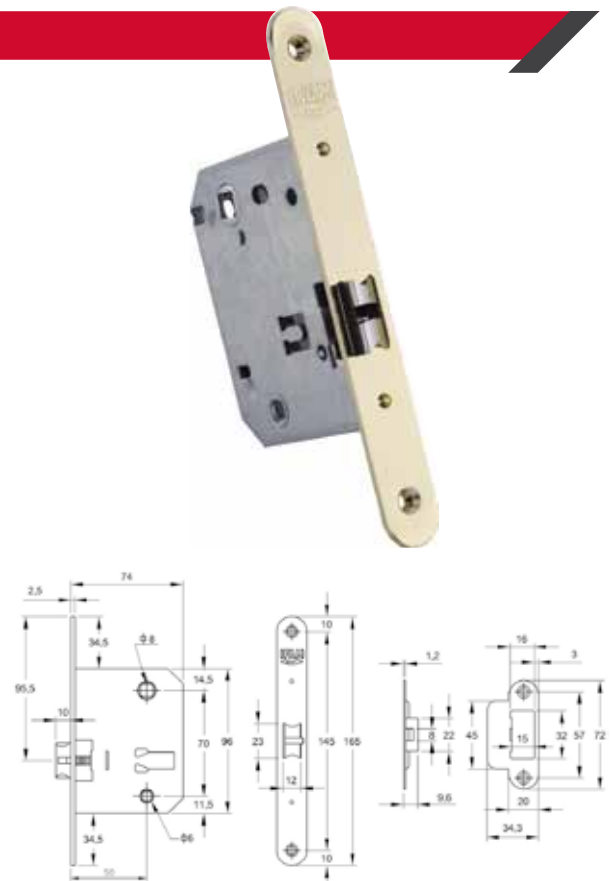

## Picaporte W147 - W147 Latch

- Picaporte para puertas de madera, con condena.
- Desbloqueo automático de condena (la condena con puerta abierta se desactiva al cerrarla).
- Distancia entre ejes de 70 mm. Entrada de 50mm. Nueca de 8 mm. Nueca de condena de 6 mm.
- Picaporte silencioso y reversible.
- Frente redondo.
- Acabado latonado o niquelado.
- Ideal para puertas de paso o condena.

- Dead locking latch for wooden doors.
- Automatic unlocking (locked open door, deactivated when closed).
- Dimensions: 47mm centres, 50mm backset, 8mm hub and 6mm locking hub.
- Reversible latch.
- Round front.
- Brass or nickel plated finish.
- Ideal for inside doors or with handle lock.

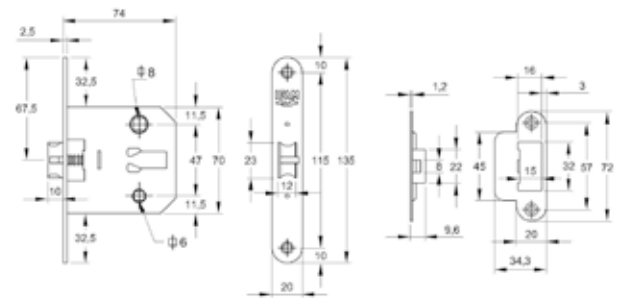

Ref.	Code	Entrada Backset	Frente Plate	IPL	Uni.
W147 RHL	W147.RHL	50		6	1
W147 RHN	W147.RHN	50		6	1

## Cerraduras de lengüeta C111 / C111 cam locks

- Cuerpo de aleación de zinc obtenido mediante fundición inyectada de alta precisión.
- Láminas de seguridad con muelles inoxidables.
- Lengüeta en acero niquelado.
- Alojamiento total de la llave en el cilindro.
- Ideal para muebles metálicos y de madera, ficheros, buzones, cajas de herramientas...

- Zinc alloy body obtained using high precision die-cast.
- Security plates with stainless steel springs.
- Nickel plated steel cam.
- Complete housing of the key in the cylinder.
- Ideal for metal and wooden furniture, file cabinets, mail boxes, tool boxes, etc.

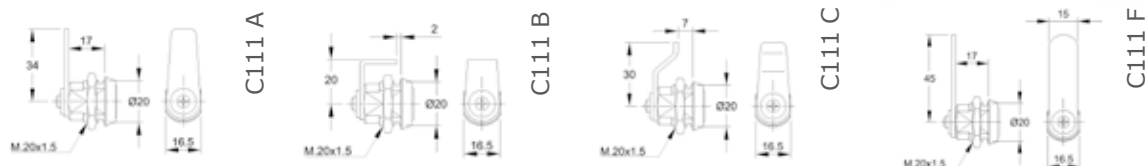

Ref.	Cod.	IPL		Pack	Uni.
111A	000253	6			20
111A BT	000251	6			6
111A KA	000261	6			20
111A KN	000262	6			20
111B	000254	6			20
111C	000255	6			20
111C BT	000252	6			6

Ref.	Cod.	IPL		Pack	Uni.
111C KA	000263	6			20
111C KN	000264	6			20
111F	000256	6			20
111F KA	000267	6			20
111F KN	000268	6			20
111 corta inox KA	000272	6			20
111 caravana	000260	6			20

## D-fender



- Escudo de alta seguridad.
  - Formado por un sólido conjunto de núcleo y coraza exterior, ambos fabricados en acero macizo y templado, con un espesor en la zona central de 15 mm.
  - Núcleo con nivel de seguridad certificado según norma EN:1303:2015. Incluye bocallaves de acero templado de 4 mm. de espesor para una máxima protección antitaladro.
  - Forma especialmente diseñada y testada por IFAM para impedir los ataques con herramientas de extracción.
  - Tetones de acero de instalación opcional. Incluidos para reforzar la seguridad ante tentativas de giro y extracción del escudo.
  - Incluye arandela suplementaria para el ajuste idóneo del núcleo del escudo, en función del grosor de la puerta.
  - El núcleo del escudo se fija a la puerta de manera independiente a la coraza exterior. En caso de una extracción forzada de la coraza, sería necesaria una nueva tentativa para extraer el núcleo del escudo.
  - Disponible en 2 tamaños (D-fender 100 y D-fender 200) y dos acabados: latón y cromo.
  - Acabado con tratamiento de galvanoplastia para proteger el escudo de rozaduras y de la corrosión.
- High security door escutcheon.
  - Solid core and outer shell unit, both made of solid tempered steel and 15 mm thick through the centre.
  - Core with EN:1303:2015 security standard certification. Includes 4 mm tempered steel keyhole cover for ultra high anti-drilling resistance.
  - Shape specially designed and tested by IFAM to stop attacks with extraction tools
  - Optional steel installation dowels included to reinforce security against torsion and face plate extraction attacks
  - Includes an extra washer so the core can be fitted perfectly into the face plate depending on the thickness of the door
  - The escutcheon's core is attached to the door independently from the outer shell. In the event of a forced shell extraction, another attack would be required to remove the face plate core.
  - Available in 2 sizes, D-Fender 100 and D-Fender 200, and 2 finishes, brass and chrome.
  - Electrotype treated finish to protect the face plate from scratches and corrosion.

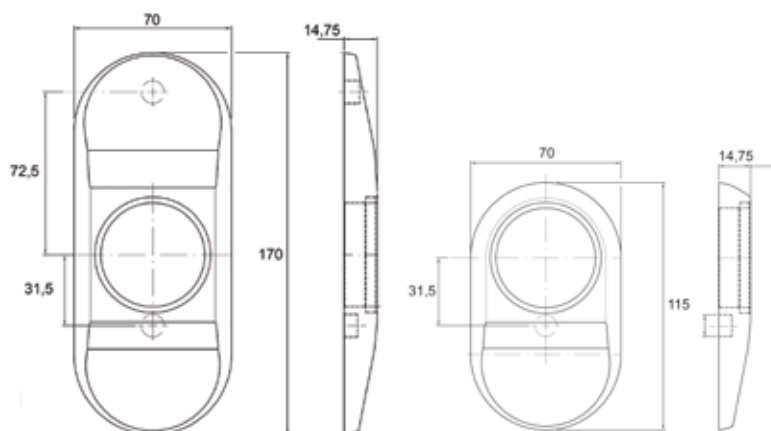

Ref.	CL.	Cod.	IPL	Pack	Uni.
D-fender 100 CM	■	025042	10		1
D-fender 100 L	■	025040	10		1
D-fender 200 CM	■	025046	10		1
D-fender 200 L	■	025044	10		1

## ES803



- Escudo certificado según Norma EN:1303:2015.
  - Muy alto nivel de protección.
  - Embellecedor macizo.
  - Escudo y bolas de acero endurecido antitaladro.
  - Núcleo de acero macizo endurecido tratado térmicamente de gran espesor.
  - Escudo de tambor de acero con 4mm de espesor y tratamiento antitaladro.
  - Dos medidas de instalación 26 mm. o 38 mm. (estándar europeo).
  - Especialmente diseñado como sistema antiextracción, antitaladro y antimordaza.
  - Válido para puertas con espesor mínimo de 35mm.
  - Fácil montaje con brocas de 6mm y 10mm. No se necesita mecanizar la puerta.
  - Opcional contraplaca de ancho 35.
- Escutcheon certified to EN:1303:2015
  - Very high protection level.
  - Solid cover plate.
  - Drill resistant hardened steel escutcheon and plate.
  - Solid thick heat treated hardened steel core.
  - Steel drum escutcheon with a thickness of 4 mm and antidrill treatment.
  - Two installation dimensions: 26mm or 38mm (European standard)
  - Anti-extraction, drill resistant and pull resistant.
  - Valid for doors with a minimum thickness of 35 mm.
  - Easy assembly using size 6 and 10 drill bits.
  - No need to mechanise the door.
  - Optional: 35mm backplate.

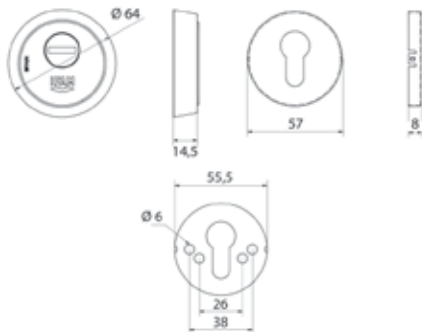

Ref.	Col.	Cod.	IPL	Pack	Uni.
ES803L		025031	9		6
ES803CM		025037	9		6

## Shield38



- Núcleo de aleación de zinc con tratamiento anticorrosión.
  - Distancia entre ejes: 38mm (acorde al estándar europeo).
  - Tapa giratoria del tambor para la entrada de la llave, fabricada en acero macizo.
  - Muelle de acero inoxidable para un ajuste perfecto entre el cilindro y el escudo.
  - Sistema antitaladro mediante dos bolas de acero macizo dispuestas sobre los tornillos de sujeción del escudo.
  - Embellecedor interior de aleación de zinc.
  - Fácil instalación con broca de 6 y 10mm.
  - Válido para puertas con un espesor mínimo de 35 mm.
  - Acabados en níquel mate y latón mate.
  - Se suministra con 2 pares de tornillos para su instalación en cualquier grosor de puerta: 2 tornillos M5x60 y dos tornillos Mx75.
- Zinc alloy core with anticorrosion treatment.
  - Fixing screw centre is 38mm (according to European standards).
  - Rotating plate for inserting the key, made of solid steel.
  - Stainless steel spring for perfect adjustment between the cylinder and the escutcheon.
  - Anti-drill system based on solid steel plates fitted to the escutcheon attachment screws.
  - Interior trim made from zinc alloy.
  - Easy installation using 6 and 10 mm drill bits.
  - Suitable for doors that are at least 35 mm thick.
  - Available in nickel and brass finish.
  - Supplied with 2 pairs of screws for installation on any door thickness: 2 M5x60 screw and two Mx75 screws.

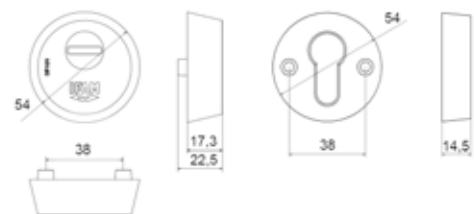

Ref.	Col.	Cod.	IPL	Pack	Uni.
Shield38 L		025020	8		10
Shield38 SC		025022	8		10

## ES610



- Escudo certificado según Norma EN:1303:2015.
- Núcleo reforzado con placas de acero. Sistema antitaladro.
- Placa protectora de tambor de acero endurecido integrado en el núcleo que imposibilita su desmontaje.
- Embellecedor giratorio de acero con diseño antimordaza.
- Diseño con sistema antiextractor.
- Placa interior de acero de 4mm.
- Acabados latón y níquel.

- Escutcheon certified to EN:1303:2015.
- Core reinforced with steel plates. Drill resistant system.
- Hardened steel drum protector plate integrated in the core, which prevents disassembling.
- Rotating steel cover with a pull resistant design.
- Design with anti-extractor system.
- 4mm steel inner plate.
- Brass and nickel plated finish.

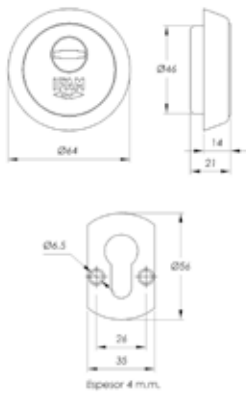

Ref.	Col.	Cod.	IPL	Pack	Uni.
ES610L		025012	7		20
ES610CM		025018	7		20

## ES385



- Especialmente recomendado para una protección lateral de los cilindros.
- Diseño antimordaza.
- Tratamiento antioxidante que aumenta su resistencia a la corrosión.
- Placa interior de acero de 4mm.
- Acabados latón y níquel.

- Specially recommended for protecting cylinders from side attacks.
- Pull resistant design.
- Rust resistant treatment, which increases its resistance to corrosion.
- 4mm steel inner plate.
- Brass and nickel plated finish.

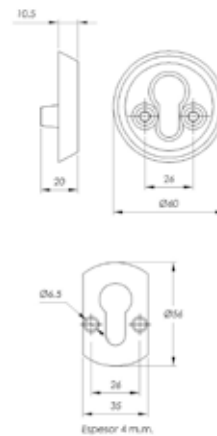

Ref.	Col.	Cod.	IPL	Pack	Uni.
ES385HL		025080	5		20
ES385HN		025084	5		20

### EZ



- Fabricado en acero pintado.
- Instalación con tornillos pasantes o roscados.
- Se utiliza como accesorio la instalación de cilindros IFAM en otras cerraduras del mercado.
- Manufactured in painted steel.
- Installation using through bolts or threaded bolts.
- Facilitates the installation of IFAM cylinders in other locks on the market.

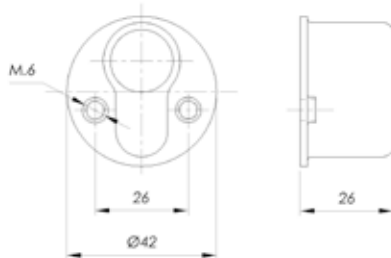

Ref.	Col.	Cod.	Pack	Uni.
EZ	■	025090	🔒	25
EZ roscado	■	025293	🔒	25
EZ roscado	■	025294	🔒	25



## Acc. cerrojos y escudos - Accessories rim locks & escutcheons

	Ref.	Cod.
	Escudo exterior CS88 M50 L Exterior escutcheon CS88 M50 L	482065
	Tirafondo fijación puerta cabeza hexagonal latón (CS88LV y CS88M50) Brass fixing screw with hexagonal head (CS88LV and CS88 M50 L)	437606
	Tirafondo fijación puerta cabeza hexagonal zinc Zinc fixing screw with hexagonal head	437605
	Lengüeta CS88LV 40 CS88LV 40 tab	482035
	Lengüeta CS88LV 45 CS88LV 45 tab	482038
	Lengüeta CS88LV 80 CS88LV 80 tab	482043
	Tornillo M3x10 CS88LV M3x10 CS88LV screw	437575
	Kit CS88LV larga Kit long CS88LV	178090
	Suplemento cerradero Surcharge for fastener	482300
	Embellecador exterior latón (Cerrojo X5) Brass exterior plate (X5 rim lock)	482310
	Embellecador exterior latón (Cerrojos B6/50 y B5/50) Brass exterior plate (B6/50 and B5/50 rim locks)	482330

	Ref.	Cod.
	Placa sujeción manilla (Escudo ES803 / ES610) Handle fastener plate (ES803 / ES610 escutcheon)	025097
	Placa sujeción roseta (Escudo ES803) Round fastener plate (ES803 escutcheon)	482360
	Bocallaves Interior latón (Escudo ES803) Interior brass keyhole (ES803)	437650
	Bocallaves Interior cromo (Escudo ES803) Interior nickel keyhole (ES803)	437660
	Tornillos sujeción (Escudo ES803) M6x50 Fixing screws M6x50 (ES803 escutcheon)	437680
	Kit alargamiento (B5 / D5) Cylinder elongation kit (B5 / D5)	482440
	Cerradero puerta madera (B6/B5/D5) Strike for wooden doors (B6 / B5 / D5 / X5)	482450
	Cerradero puerta metálica (B6/B5/D5/X5) Strike for metal doors (B6 / B5 / D5 / X5)	482460
	Palanca 160 mm (B6 / B5 / D5) 160mm lever (B6 / B5 / D5)	482470
	Palanca 200 mm (B6 / B5 / D5) 200mm lever (B6 / B5 / D5)	482480
	Contraplaca cerrojo X5 Counterplate X5 rim lock	482490



# IFAM



## CANDADOS PADLOCKS

**ALTA SEGURIDAD**  
HIGH SECURITY



PÁG.  
44

**SEGURIDAD**  
SECURITY



PÁG.  
46

**SERIE K**  
K SERIES



PÁG.  
48

**SERIE TIFON**  
TIFON SERIES



PÁG.  
50

**SERIE Z**  
Z SERIES



PÁG.  
52

**SERIE STEELUS**  
STEELUS SERIES



PÁG.  
53

**RESISTENCIA A  
LA OXIDACIÓN**  
RESISTANCE  
TO CORROSION



PÁG.  
54

**DISEÑO Y  
COMBINACIÓN**  
COMBINATION  
AND DESIGN



PÁG.  
58

**PORTA-  
CANDADOS**  
HASPS AND  
STAPLES



PÁG.  
68

### Titán



- Grado 6 según norma EN12320.
- Cuerpo de acero cementado con revestimiento de níquel. Máxima resistencia a la oxidación.
- Cierre de doble enganche con bolas de acero de alta resistencia.
- Arco de acero anticizalla de 14 mm. de diámetro, carbonitrurado.
- Bombillo antiganzúa con doble escudo de acero. Máxima seguridad.
- Ideal para lugares de alto riesgo de robo: garajes, almacenes, contenedores de transporte.
- Se suministra con 3 llaves de puntos de seguridad con millones de combinaciones.
- Combina con: cilindros Serie M+ (Anti Snap) y Serie M; candado Huno 80; cerrojos CS88 M50/M70, CS88 LV y B6.

- Standard EN12320 Grade 5.
- Hardened steel body with nickel plating. Maximum resistance to rust.
- Double locking mechanism with high resistant steel ball bearings.
- Bolt-cutter proof steel shackle measuring 14 mm in diameter, with carbon nitride coating.
- Pick proof tumbler with double steel escutcheon. Maximum security.
- Ideal for locations with a high risk of theft: garages, warehouses, shipping containers.
- Supplied with 3 security dimple keys with millions of differs.
- Key compatible with: M+ (Anti Snap) Series and M Series cylinders, Huno 80 padlock and CS88 M50/M70, CS88LV and B6 rim locks.

### Huno 80



- Grado 5 según norma EN12320
- Cuerpo y arco de acero aleado de altas prestaciones.
- Arco de acero de 14 mm. de diámetro.
- Anillo protector para impedir el corte del arco.
- Cierre mediante bola de acero de alta resistencia.
- Escudo protector antitaladro de acero de 4 mm. de espesor.
- Ideal para lugares de alto riesgo de robo: persianas de comercios, almacenes, contenedores de transporte...
- Se suministra con 3 llaves de puntos de seguridad con millones de combinaciones.
- Combina con: cilindros Serie M+ (Anti Snap) y Serie M; candado Titán; cerrojos CS88 M50/M70, CS88 LV y B6.

- Standard EN12320 Grade 5.
- High performance steel alloy body and shackle.
- Steel shackle measuring 14 mm in diameter.
- Protector ring to prevent cutting the shackle.
- High resistant steel ball bearing lock.
- Drill resistant protector escutcheon made with 4 mm thick steel.
- Ideal for locations with a high risk of theft: garages, warehouses, shipping containers.
- Supplied with 3 security dimple keys with millions of differs.
- Key compatible with: M+ (Anti Snap) Series and M Series cylinders, Titan padlock and CS88 M50/M70, CS88LV and B6 rim locks.

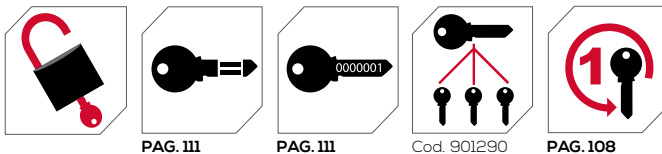

PAG. 111

PAG. 111

Cod. 901290

PAG. 108

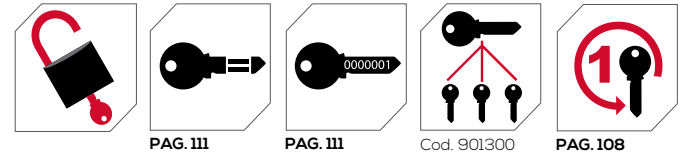

PAG. 111

PAG. 111

Cod. 901300

PAG. 108

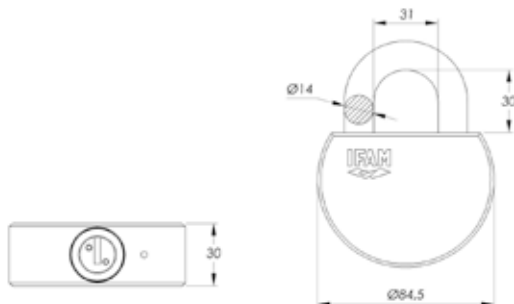

PAG. 111

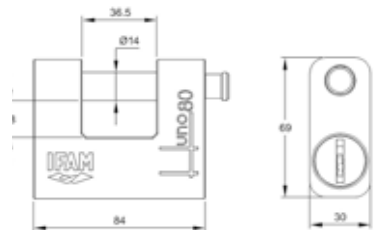

Ref.	Code	IPL		Pack	Uds
Titán	051400	10			4
Titán KA	051405	10			4
Titán KN	051407	10			4

Ref.	Code	IPL		Pack	Uds
Huno 80	051900	10			6
Huno 80 KA	051905	10			6
Huno 80 KN	051907	10			6

## Hércules A / Hércules B



HERCULES A



HERCULES B



- Grado 4 según norma EN12320 (Hércules B) y Grado 3 (Hércules A).
- Cuerpo de acero carbonitrurado con revestimiento de níquel antioxidación.
- Arco de acero aleado al cromo-níquel-molibdeno templado y cromado.
- Protector de arco anticizalla y antipalanca (Hércules A).
- Sistema de doble enganche por bolas de acero.
- Bombillo antiganzúa con protección antitaladro mediante dos escudos de acero carbonitrurado y niquelado.
- Ideal para lugares de alto riesgo de robo: garajes, almacenes, contenedores de transporte.
- Se suministra con 3 llaves de puntos de seguridad con millones de combinaciones.
- Llave compatible con: antirrobo de moto Disk giant, Traveller Mini Secure y cadena Top Giant.

- Standard EN12320 Grade 4 (Hercules B) and Grade 3 (Hercules A).
- Carbon nitrate plated steel body with nickel rust resistant plating.
- Chrome-nickel-molybdenum alloy steel shackle, hardened and chrome plated.
- Bolt-cutter proof and lever proof shackle protector (Hercules A).
- Double locking system using steel ball bearings.
- Pick proof tumbler with drill resistant protection by means of two carbon nitrate and nickel plated escutcheons.
- Ideal for locations with a high risk of theft: garages, warehouses, shipping containers.
- Supplied with 3 security dimple keys with millions of differs.
- Key compatible with: Disk giant, Traveller Mini Secure and Top Giant motorcycle locks.



Hercules B

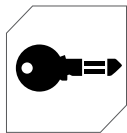

PAG. 111

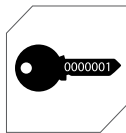

PAG. 111



Cod. 901310



PAG. 111

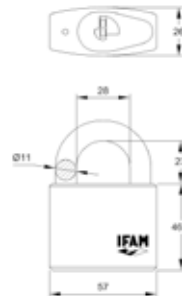
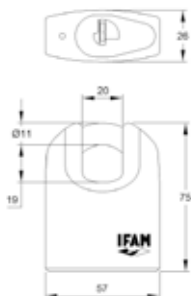

Ref.	Code	IPL		Pack	Uds
Hércules A	051200	10			3
Hércules A KA	051205	10			3
Hércules A KN	051207	10			3

Ref.	Code	IPL		Pack	Uds
Hércules B	051300	10			6
Hércules B KA	051305	10			6
Hércules B KN	051307	10			6

## Serie Armoured S / Serie Armoured



ARMOURED S



ARMOURED

- Norma EN12320 con Grado 4.
- Cuerpo de latón cubierto de coraza de acero endurecido y cromado.
- Condena de acero endurecido y cromado.
- Cilindro de latón con protección anti-taladro.
- Dos versiones: Armoured S, con llave de puntos de seguridad, y Armoured con llave de serreta.
- Ambos modelos se suministran con 2 llaves.
- La llave de los candados Armoured S es compatible con cilindros Serie M+ (Anti Snap) y Serie M; candados Titán y Huno 80; cerrojos CS88 M50/M70, CS88 LV y B6.
- La llave de los candados Armoured es compatible con: cilindros serie D; candados K50, Cable Inox, Max50 y Serie U; cerraduras CS125 y CS126.

- Standard EN12320 Grade 4.
- Brass body covered by a hardened and chrome plated casing.
- Hardened and chrome plated steel lock.
- Brass cylinder with drill resistant protection.
- Two versions: Armoured S, with security dimple keys, and Armoured, with standard key.
- Supplied with 2 keys,
- Armoured S padlock's key is compatible with: M+ (Anti Snap) and M Series cylinders; Titan and Huno 80 padlocks; CS88 M50/M70, CS88 LV and B6 rim locks.
- Armoured padlock's key is compatible with: D Series cylinders; K50, Inox Cable, Max50 and U Series padlocks; CS125 and CS126 locks.

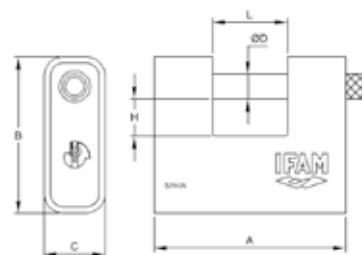
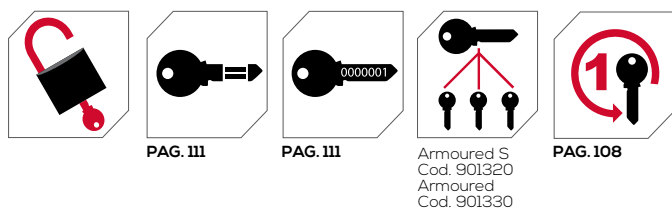

Ref.	Cod.	IPL	A	B	C	D	L	H	Pack	Uni	
<b>ARMOURED S (Llave de puntos) - ARMOURED S (dimple key)</b>											
ARM80 S	052180	8	82	69	29	11	30	14			6
ARM80 S	052181	8	82	69	29	11	30	14			3
ARM80 S KN	052187	8	82	69	29	11	30	14			6
ARM90 S	052190	8	91,7	75	29,2	12	35,7	18			6
ARM90 S	052191	8	91,7	75	29,2	12	35,7	18			3
ARM90 S KN	052197	8	91,7	75	29,2	12	35,7	18			6

Ref.	Cod.	IPL	A	B	C	D	L	H	Pack	Uni	
<b>SERIE ARMOURED - ARMOURED SERIES</b>											
ARM60	052060	7	62,6	55,7	24,3	10	22	11			6
ARM60	052061	7	62,6	55,7	24,3	10	22	11			3
ARM60 KA	052065	7	62,6	55,7	24,3	10	22	11			6
ARM60 KN	052067	7	62,6	55,7	24,3	10	22	11			6
ARM80	052080	7	82	69	29	11	30	14			6
ARM80	052081	7	82	69	29	11	30	14			3
ARM80 KA	052085	7	82	69	29	11	30	14			6
ARM80 KN	052087	7	82	69	29	11	30	14			6
ARM90	052090	7	91,7	75	29,2	12	35,7	18			6
ARM90	052091	7	91,7	75	29,2	12	35,7	18			3
ARM90 KA	052095	7	91,7	75	29,2	12	35,7	18			6
ARM90 KN	052097	7	91,7	75	29,2	12	35,7	18			6

## Serie U - U Series



- Cuerpo de latón extruido.
- Arco de acero carbonitrurado y cromado con apertura automática.
- Mecanismo de cierre mediante bola.
- Extracción de la llave sólo en posición de cerrado.
- Se suministra con 2 llaves.
- Llave compatible con: cilindros Serie D, cerrojo B5, candados K50, Inox Plus50, Inox50, Inox Cable, Max50 y Serie Armoured; cerraduras CS125 y CS126.

- Extruded brass body.
- Carbon nitrate and chrome plated steel shackle with automatic opening system.
- Ball bearing locking mechanism.
- Key retaining.
- Supplied with 2 keys.
- Key compatible with: D Series cylinders; K50, Inox50, Inox Cable, Max50 and Armoured Series padlocks; B5 rim lock; CS125 and CS126 locks.

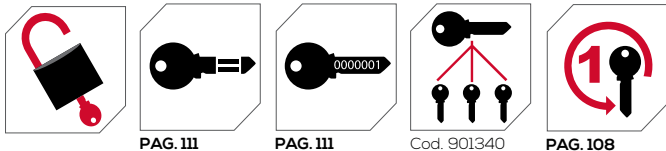

PAG. 111

PAG. 111

Cod. 901340

PAG. 108



PAG. 111

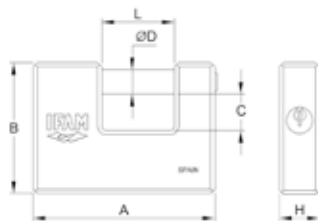

Ref.	Cod.	IPL	A	B	C	D	L	H	Pack	Uni
U70	000770	6	70	55	15,5	12	22	20		6
U70 KA	000775	6	70	55	15,5	12	22	20		6
U70 KN	000777	6	70	55	15,5	12	22	20		6
U90	000790	6	90	64,5	17,5	12	36	20		6
U90 KA	000795	6	90	64,5	17,5	12	36	20		6
U90 KN	000797	6	90	64,5	17,5	12	36	20		6

## S360



- Norma EN12320 con Grado 4.
- Cuerpo y arco de acero aleado de altas prestaciones y gran resistencia a la oxidación.
- Cierre de doble enganche mediante bolas de acero.
- Arco de acero de 11 mm. de diámetro.
- Bombillo con pasadores de acero antitaladro y siete pitones en línea.
- Se suministra con 3 llaves de 7 pitones.

- Standard EN12320 Grade 4.
- High performance steel alloy body and shackle with a high resistance to rust.
- Double locking system using steel ball bearings.
- Steel shackle measuring 11 mm in diameter.
- Tumbler with drill resistant steel pins and seven pins in line.
- Supplied with 3 keys.

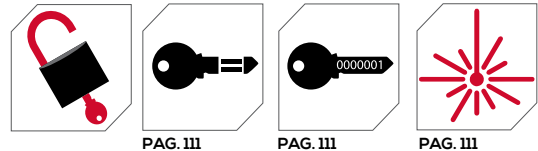

PAG. 111

PAG. 111

PAG. 111

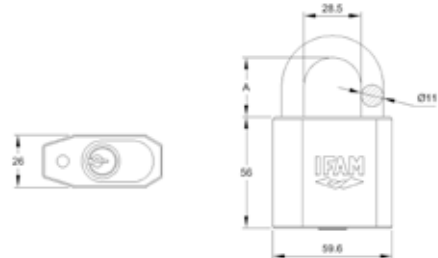

Ref.	Cod.	IPL	A	Pack	Uni
<b>ARCO NORMAL - STANDARD SHACKLE</b>					
S360	051700	9	30		3
S360 KA	051705	9	30		3
S360 KN	051707	9	30		3
S360 sin cilindro	051700s	9	30		3
<b>ARCO LARGO - LONG SHACKLE</b>					
S360AL	051710	9	50		3
S360AL KA	051715	9	50		3
S360AL KN	051717	9	50		3

## Serie K - K Series

- Cuerpo de latón extruido.
- Arco de acero carbonitrurado, templado y cromado.
- Sistema automático de doble enganche.
- Bombillo con sistema de seguridad antiganzúa.
- Muelles de acero inoxidable AISI 316.
- Disponible en 5 versiones de arco: normal, largo, extralargo, protegido y adaptable.
- Ideal para variados usos: protección de taquillas, maletas, cajas de herramientas, acoplado a cadenas...
- Se suministra con 2 llaves.
- La llave del candado K50 combina con: cilindros Serie D, candados Inox50, Max50, Armoured y Serie U, cerraduras CS125 y CS126.

- Extruded brass body.
- Carbon nitrate hardened and chrome plated steel shackle.
- Automatic double locking system.
- Tumbler cylinder with pick proof system.
- AISI 316 stainless steel springs.
- Available with 5 shackle versions: Standard, long, extra-long and protected shackle.
- Ideal for various uses: protection of lockers, luggage, tool boxes, coupled to chains, etc.
- Supplied with 2 keys.
- K50 padlock's key is compatible with: D Series cylinders, Inox50, Inox Cable, Max50, Armoured Series and U Series padlocks; CS125 and CS126 locks.



PAG. 108



PAG. 111



K20  
K30

Ref.	Cod.	IPL	A	B	C	D	L		Pack	Uni.
<b>ARCO NORMAL - STANDARD SHACKLE</b>										
K15	011500	6	17,5	17	11	3	8,2			12
K15	011501	6	17,5	17	11	3	8,2			6
K15 KA	011505	6	17,5	17	11	3	8,2			12
K15 KN	011507	6	17,5	17	11	3	8,2			12
K20	012000	6	21	21,5	13,5	10,5	10,5			12
K20	012001	6	21	21,5	13,5	10,5	10,5			6
K20 KA	012005	6	21	21,5	13,5	10,5	10,5			12
K20 KN	012007	6	21	21,5	13,5	10,5	10,5			12
K20 (Pack 3)	012003	6	21	21,5	13,5	10,5	10,5			6
K25	012500	6	25	22,5	17	4	13			12
K25	012501	6	25	22,5	17	4	13			6
K25 KA	012505	6	25	22,5	17	4	13			12
K25 KN	012507	6	25	22,5	17	4	13			12
K30	013000	6	30	27	17,5	5	15,5			12
K30	013001	6	30	27	17,5	5	15,5			6
K30 KA	013005	6	30	27	17,5	5	15,5			12
K30 KN	013007	6	30	27	17,5	5	15,5			12
K30 (Pack 3)	013003	6	30	27	17,5	5	15,5			6
K40	014000	6	40	32	22,5	6	23			12
K40	014001	6	40	32	22,5	6	23			6
K40 KA	014005	6	40	32	22,5	6	23			12
K40 KN	014007	6	40	32	22,5	6	23			12
K50	015000	7	50	40	27,5	8	29			6

Ref.	Cod.	IPL	A	B	C	D	L		Pack	Uni.
K50	015001	7	50	40	27,5	8	29			6
K50 KA	015005	7	50	40	27,5	8	29			6
K50 KN	015007	7	50	40	27,5	8	29			6
K60	016000	7	60	46	33	9,5	35,5			6
K60	016001	7	60	46	33	9,5	35,5			6
K60 KA	016005	7	60	46	33	9,5	35,5			6
K60 KN	016007	7	60	46	33	9,5	35,5			6
K70	017000	8	70	50	41	11,2	40,5			6
K70 KA	017005	8	70	50	41	11,2	40,5			6
K70 KN	017007	8	70	50	41	11,2	40,5			6
<b>ARCO LARGO - LONG SHACKLE</b>										
K20AL	012010	6	21	21,5	23,5	3,5	10,5			12
K20AL	012011	6	21	21,5	23,5	3,5	10,5			6
K20AL KA	012015	6	21	21,5	23,5	3,5	10,5			12
K20AL KN	012017	6	21	21,5	23,5	3,5	10,5			12
K25AL	012510	6	25	22,5	25	4	13			12
K25AL	012511	6	25	22,5	25	4	13			6
K25AL KA	012515	6	25	22,5	25	4	13			12
K25AL KN	012517	6	25	22,5	25	4	13			12
K30AL	013010	6	30	27	32	5	15,5			12
K30AL	013011	6	30	27	32	5	15,5			6
K30AL KA	013015	6	30	27	32	5	15,5			12
K30AL KN	013017	6	30	27	32	5	15,5			12
K40AL	014010	6	40	32	43	6	23			12



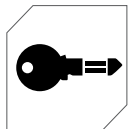
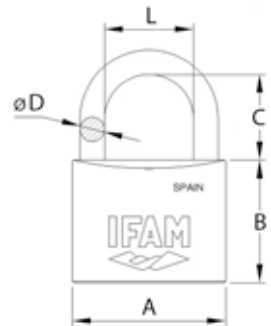

PAG. III

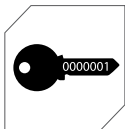

PAG. III



Cod. 901350



Cod. 178110

Ref.	Cod.	IPL	A	B	C	D	L		Pack	Uni.
K40AL	014011	6	40	32	43	6	23			6
K40AL KA	014015	6	40	32	43	6	23			12
K40AL KN	014017	6	40	32	43	6	23			12
K50AL	015010	7	50	40	49	8	29			6
K50AL	015011	7	50	40	49	8	29			6
K50AL KA	015015	7	50	40	49	8	29			6
K50AL KN	015017	7	50	40	49	8	29			6
K60AL	016010	7	60	46	51	9,5	35,5			6
K60AL	016011	7	60	46	51	9,5	35,5			6
K60AL KA	016015	7	60	46	51	9,5	35,5			6
<b>ARCO EXTRALARGO - EXTRALONG SHACKLE</b>										
K30AEL	013020	6	30	27	50	5	15,5			6
K30AEL	013021	6	30	27	50	5	15,5			6
K30AEL KA	013025	6	30	27	50	5	15,5			6
K30AEL KN	013027	6	30	27	50	5	15,5			6
K40AEL	014020	6	40	32	65	6	23			6
K40AEL	014021	6	40	32	65	6	23			6
K40AEL KA	014025	6	40	32	65	6	23			6
K40AEL KN	014027	6	40	32	65	6	23			6
K50AEL	015020	7	50	40	80	8	29			6
K50AEL	015021	7	50	40	80	8	29			6
K50AEL KA	015025	7	50	40	80	8	29			6
K50AEL KN	015027	7	50	40	80	8	29			6

Ref.	Cod.	IPL	A	B	C	D	L		Pack	Uni.
<b>ARCO PROTEGIDO - PROTECTED SHACKLE</b>										
K40AP	014040	7	40	32	13,5	6	10			12
K40AP	014041	7	40	32	13,5	6	10			12
K40AP KA	014045	7	40	32	13,5	6	10			12
K40AP KN	014047	7	40	32	13,5	6	10			12
K50AP	015040	8	50	40	17	8	13			6
K50AP	015041	8	50	40	17	8	13			6
K50AP KA	015045	8	50	40	17	8	13			6
K50AP KN	015047	8	50	40	17	8	13			6
K50AP Uso general	015049	8	50	40	17	8	13			6
K60AP	016040	8	60	46	23	9,5	17			6
K60AP	016041	8	60	46	23	9,5	17			6
K60AP KA	016045	8	60	46	23	9,5	17			6
K60AP KN	016047	8	60	46	23	9,5	17			6
<b>ARCO ADAPTABLE - ADJUSTABLE SHACKLE</b>										
K50AD	015061	7	50	40	AD	8	29			6

## Serie Tifón - Tifon Series

- Cuerpo de latón extruido.
- Arco de acero endurecido.
- Sistema de doble enganche.
- Muelles de acero inoxidable AISI 304.
- Pasadores de bloqueo con tratamiento antioxidación.
- Excelente relación calidad-precio.
- Apto para todo tipo de usos, tanto en interior como en exterior, con la garantía de calidad IFAM.
- Se suministra con 2 llaves.

- Extruded brass body.
- Hardened steel shackle.
- Double locking system (from 30mm).
- AISI 304 stainless steel springs.
- Rust resistant locking pins.
- Excellent price to quality ratio.
- Suitable for all types of uses; indoors as well as outdoors, and quality guaranteed by IFAM.
- Supplied with 2 keys.



PAG. 111



TF25  
TF30

Ref.	Cod.	IPL	A	B	C	D	L		Pack	Uni.
<b>ARCO NORMAL - STANDARD SHACKLE</b>										
TF15	071500	5	16	18	13	3	8			12
TF15	071501	5	16	18	13	3	8			6
TF15 KN	071507	5	16	18	13	3	8			12
TF20	072000	5	19,5	20	11	3,2	9,5			12
TF20	072001	5	19,5	20	11	3,2	9,5			6
TF20 KN	072007	5	19,5	20	11	3,2	9,5			12
TF25	072500	5	25	24	14	4,5	12,5			6
TF25	072501	5	25	24	14	4,5	12,5			6
TF25 KN	072507	5	25	24	14	4,5	12,5			6
TF25 (Pack 3)	072503	5	25	24	14	4,5	12,5			6

Ref.	Cod.	IPL	A	B	C	D	L		Pack	Uni.
TF30	073000	6	29	27	16	4,8	15,7			6
TF30	073001	6	29	27	16	4,8	15,7			6
TF30 KN	073007	6	29	27	16	4,8	15,7			6
TF30 (Pack 3)	073003	6	29	27	16	4,8	15,7			6
TF40	074000	6	39	33	22	6,3	22			6
TF40	074001	6	39	33	22	6,3	22			6
TF40 KN	074007	6	39	33	22	6,3	22			6
TF50	075000	6	48	40	24	7	26,7			6
TF50	075001	6	48	40	24	7	26,7			6
TF50 KN	075007	6	48	40	24	7	26,7			6
TF60	076000	6	58	43	34	8,7	33			6
TF60	076001	6	58	43	34	8,7	33			6

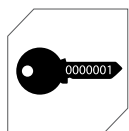
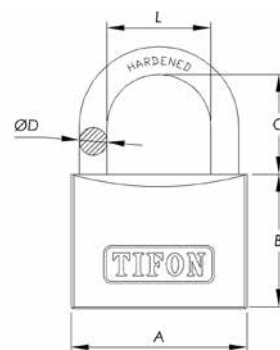

PAG. III

Ref.	Cod.	IPL	A	B	C	D	L		Pack	Uni.
TF60 KN	076007	6	58	43	34	8,7	33			6
<b>ARCO LARGO - LONG SHACKLE</b>										
TF20AL	072010	5	19	20	21,5	3,2	9,5			12
TF20AL	072011	5	19	20	21,5	3,2	9,5			6
TF20AL KN	072017	5	19	20	21,5	3,2	9,5			12
TF25AL	072510	5	25	24	24	4	12,5			6
TF25AL	072511	5	25	24	24	4	12,5			6
TF25AL KN	072517	5	25	24	24	4	12,5			6
TF30AL	073010	6	29	27	33	4,8	15,7			6
TF30AL	073011	6	29	27	33	4,8	15,7			6
TF30AL KN	073017	6	29	27	33	4,8	15,7			6

Ref.	Cod.	IPL	A	B	C	D	L		Pack	Uni.
TF40AL	074010	6	39	33	38	6,3	22			6
TF40AL	074011	6	39	33	38	6,3	22			6
TF40AL KN	074017	6	39	33	38	6,3	22			6
TF50AL	075010	6	48	40	48	7	26,7			6
TF50AL	075011	6	48	40	48	7	26,7			6
TF50AL KN	075017	6	48	40	48	7	26,7			6
TF60AL	076010	6	58	43	51	8,7	33			6
TF60AL	076011	6	58	43	51	8,7	33			6
TF60AL KN	076017	6	58	43	51	8,7	33			6



## Serie Z - Z Series



- Candados con buena resistencia a la corrosión, mediante una aleación especial de zinc.
- Cuerpo obtenido mediante fundición inyectada de alta precisión.
- Arco de acero cromado.
- Muelles de acero inoxidable.
- Excelente durabilidad.
- Especialmente resistente a los productos químicos.

- Good resistance to corrosion padlocks, thanks to their special zinc alloy.
- Body obtained using high precision die-cast.
- Hardened steel shackle.
- Stainless steel springs.
- Excellent durability.
- Specially resistant to chemical agents.

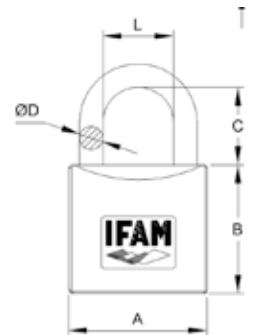
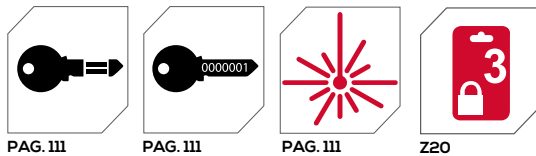

Ref.	Cod.	IPL	A	B	C	D	L		Pack	Uni.
<b>ARCO NORMAL - STANDARD SHACKLE</b>										
Z15	001500	5	17,5	17,5	10,5	3	8			12
Z15	001501	5	17,5	17,5	10,5	3	8			6
Z15 KA	001505	5	17,5	17,5	10,5	3	8			12
Z15 KN	001507	5	17,5	17,5	10,5	3	8			12
Z20	002000	5	22	22,5	13	4	11			12
Z20	002001	5	22	22,5	13	4	11			6
Z20 KA	002005	5	22	22,5	13	4	11			12
Z20 KN	002007	5	22	22,5	13	4	11			12
Z20 (Pack 3)	002003	5	22	22,5	13	4	11			6
Z25	002500	6	26,5	27	14,5	5	12			12
Z25	002501	6	26,5	27	14,5	5	12			6
Z25 KA	002505	6	26,5	27	14,5	5	12			12
Z25 KN	002507	6	26,5	27	14,5	5	12			12
Z35	003500	6	34,5	34,5	19,5	6	17			12
Z35	003501	6	34,5	34,5	19,5	6	17			6
Z35 KA	003505	6	34,5	34,5	19,5	6	17			12
Z35 KN	003507	6	34,5	34,5	19,5	6	17			12
Z45	004500	6	44	41,5	25	7,5	23			6
Z45	004501	6	44	41,5	25	7,5	23			6
Z45 KA	004505	6	44	41,5	25	7,5	23			6

Ref.	Cod.	IPL	A	B	C	D	L		Pack	Uni.
Z45 KN	004507	6	44	41,5	25	7,5	23			6
Z55	005500	6	54	44,5	25	8,5	30			6
Z55	005501	6	54	44,5	25	8,5	30			6
Z55 KA	005505	6	54	44,5	25	8,5	30			12
Z55 KN	005507	6	54	44,5	25	8,5	30			12
<b>ARCO LARGO - LONG SHACKLE</b>										
Z20AL	002010	5	22	22,5	21	4	11			12
Z20AL	002011	5	22	22,5	21	4	11			6
Z20AL KA	002015	5	22	22,5	21	4	11			12
Z20AL KN	002017	5	22	22,5	21	4	11			12
Z25AL	002510	6	26,5	27	25,5	5	12			12
Z25AL	002511	6	26,5	27	25,5	5	12			6
Z25AL KA	002515	6	26,5	27	25,5	5	12			12
Z25AL KN	002517	6	26,5	27	25,5	5	12			12
Z35AL	003510	6	34,5	34,5	29	6	17			12
Z35AL	003511	6	34,5	34,5	29	6	17			6
Z35AL KA	003515	6	34,5	34,5	29	6	17			12
Z35AL KN	003517	6	34,5	34,5	29	6	17			12
Z45AL	004510	6	44	41,5	40	7,5	23			6
Z45AL	004511	6	44	41,5	40	7,5	23			6
Z45AL KA	004515	6	44	41,5	40	7,5	23			6
Z45AL KN	004517	6	44	41,5	40	7,5	23			6

# Serie Steelus - Steelus Series

## Serie Steelus - Steelus Series

N



- Cuerpo macizo de acero con gran resistencia anticorte.
- Arco de acero endurecido.
- Cierre con sistema de doble enganche.
- Muelles y condensa de arco de acero inoxidable
- Cilindro y pitones de latón para evitar la oxidación y asegurar un correcto funcionamiento con el paso del tiempo.
- Pintura de gran espesor para prevenir la oxidación.
- Se suministra con dos llaves de acero.
- Excelente relación calidad-precio.

- Solid steel body with extreme anti-cut resistance.
- Hardened steel shackle.
- Double lock closure system.
- Stainless steel shackle latch and springs.
- Brass cylinder and pins to avoid rust and ensure correct operation over time.
- Thick paint layer to prevent rust.
- Supplied with two steel keys.
- Excellent value for money.

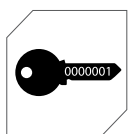

PAG. III



PAG. III

Ref.	Cod.	A	B	C	D	L		Pack	Uni.
<b>ARCO NORMAL - STANDARD SHACKLE</b>									
ST20	072000ST	21	21	13,5	3,25	11			12
ST20 KN	072007ST	21	21	13,5	3,25	11			12
ST25	072500ST	25	24	14,5	4,25	12,5			6
ST25 KN	072507ST	25	24	14,5	4,25	12,5			6
ST30	073000ST	32	30	16,5	5,25	17			6
ST30 KN	073007ST	32	30	16,5	5,25	17			6
ST40	074000ST	38	34	21	6,25	20			6
ST40 KN	074007ST	38	34	21	6,25	20			6
ST50	075000ST	50	41	26	9	25			6
ST50 KN	075007ST	50	41	26	9	25			6
ST60	076000ST	63	50	33	10,5	32,5			6
ST60 KN	076007ST	63	50	33	10,5	32,5			6

Ref.	Cod.	A	B	C	D	L		Pack	Uni.
<b>ARCO LARGO - LONG SHACKLE</b>									
ST20AL	072010ST	21	21	23,5	3,25	11			6
ST20AL KN	072017ST	21	21	23,5	3,25	11			6
ST25AL	072510ST	25	24	26	4,25	12,5			6
ST25AL KN	072517ST	25	24	26	4,25	12,5			6
ST30AL	073010ST	32	30	48	5,25	17			6
ST30AL KN	073017ST	32	30	48	5,25	17			6
ST40AL	074010ST	38	34	56,5	6,25	20			6
ST40AL KN	074017ST	38	34	56,5	6,25	20			6
ST50AL	075010ST	50	41	61	9	25			6
ST50AL KN	075017ST	50	41	61	9	25			6
ST60AL	076010ST	63	50	73	10,5	32,5			6
ST60AL KN	076017ST	63	50	73	10,5	32,5			6

## InoxTop



- El tope de gama de la serie de candados inoxidables de IFAM.
- 100% acero inoxidable AISI 316: arco, cuerpo, cilindro y componentes internos.
- Diseñado para resistir en las condiciones de humedad y corrosión más extremas.
- Cierre con doble bola de acero inoxidable.
- Sistema de retención de llave con el candado abierto.
- Llave de discos de alta seguridad fabricada en alpaca.
- Se suministra con 3 llaves.
- Consultar servicios de llaves iguales y de nº determinado.

- The top of the IFAM corrosion resistant series of padlocks.
- 100% stainless steel: shackle, body, cylinder and internal components.
- Designed to resist the toughest humid and corrosive conditions.
- Stainless steel double ball locking.
- Key retention system when the padlock is open.
- Security disc type key. Supplied with 3 keys.
- Consult for keying alike and certain key number services.

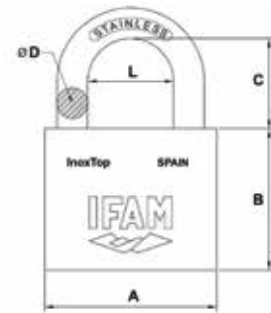

Cod. 901610

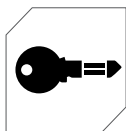

Cod. 901620

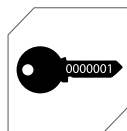

Cod. 901630



PAG. III



Ref.	Cod.	ICR	A	B	C	D	L		Pack	Uni
InoxTop 40	069240	10	40	34	22	8	19,5			6
InoxTop 40 KN	069247	10	40	34	22	8	19,5			6
InoxTop 50	069250	10	50	40	28	10	23			6
InoxTop 50 KN	069257	10	50	40	28	10	23			6
InoxTop 60	069260	10	60	44,5	29,5	12	27			6
InoxTop 60 KN	069267	10	60	44,5	29,5	12	27			6

## Serie Inox - Inox Series



- Arco de acero inoxidable AISI 316.
- Cuerpo fabricado en latón extruido de alta calidad, tratado especialmente contra la oxidación mediante baños de níquel y cromo.
- Todos los componentes internos son inoxidables: muelles, pasadores de bloqueo, tapa...
- Sistema de doble enganche con tratamiento antioxidación.
- Máxima resistencia a la oxidación en ensayos de cámara de niebla salina ASTM B-117, DIN 50021, ISO 3768.
- Cilindro cromado de alta precisión.
- Se suministra con 2 llaves.
- La llave del candado Inox50 combina con: cilindros Serie D; candados Inox Cable, Max50, K50, Serie Armoured y Serie U; cerrojo B5/50; cerraduras CS125 y CS126.

- AISI 316 stainless steel shackle,
- Body manufactured in high quality extruded brass, special treatment against rust by means of a nickel and chrome plating.
- Springs, locking pins and cover all made of stainless steel.
- Double locking system with a rust resistant treatment.
- Great resistance to rust in salt spray testing ASTM B-117, DIN 50021, ISO 3768.
- High precision chrome plated cylinder.
- Supplied with 2 keys.
- Inox50 padlock's key is compatible with: D Series cylinders; Inox Cable, Max50, K50, Armoured Series and U Series padlocks; B5/50 rim lock, CS125 and CS126 locks.

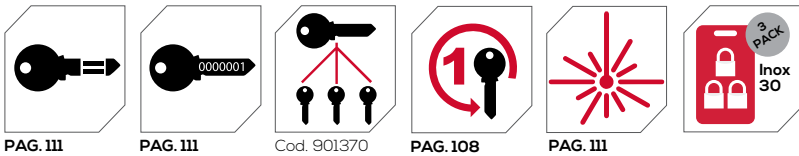
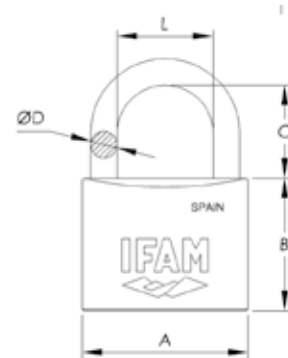

Ref.	Cod.	ICR	A	B	C	D	L		Pack	Uni.
<b>ARCO NORMAL - NORMAL SHACKLE</b>										
Inox30	083000	8	30	27	17,5	5	15,5			12
Inox30	083001	8	30	27	17,5	5	15,5			6
Inox30 KA	083005	8	30	27	17,5	5	15,5			12
Inox30 KN	083007	8	30	27	17,5	5	15,5			12
Inox30 (Pack 3)	083003	8	30	27	17,5	5	15,5			12
Inox40	084000	8	40	32	22,5	6	23			12
Inox40	084001	8	40	32	22,5	6	23			6
Inox40 KA	084005	8	40	32	22,5	6	23			12
Inox40 KN	084007	8	40	32	22,5	6	23			12
Inox50	085000	8	50	40	27	8	29			6
Inox50	085001	8	50	40	27	8	29			6
Inox50 KA	085005	8	50	40	27	8	29			6
Inox50 KN	085007	8	50	40	27	8	29			6
Inox60	086000	8	60	45	33	9,5	35			6
Inox60	086001	8	60	45	33	9,5	35			6

Ref.	Cod.	ICR	A	B	C	D	L		Pack	Uni.
Inox60 KA	086005	8	60	45	33	9,5	35			6
Inox60 KN	086007	8	60	45	33	9,5	35			6
<b>ARCO LARGO - LONG SHACKLE</b>										
Inox30AL	083010	8	30	27	32	5	15,5			12
Inox30AL	083011	8	30	27	32	5	15,5			6
Inox30AL KA	083015	8	30	27	32	5	15,5			12
Inox30AL KN	083017	8	30	27	32	5	15,5			12
Inox40AL	084010	8	40	32	42,5	6	23			12
Inox40AL	084011	8	40	32	42,5	6	23			6
Inox40AL KA	084015	8	40	32	42,5	6	23			12
Inox40AL KN	084017	8	40	32	42,5	6	23			12
Inox50AL	085010	8	50	40	48,5	8	29			6
Inox50AL	085011	8	50	40	48,5	8	29			6
Inox50AL KA	085015	8	50	40	48,5	8	29			6
Inox50AL KN	085017	8	50	40	48,5	8	29			6

## Cable Inox - Inox Cable



- Cable acerado de 6 mm. de diámetro recubierto de PVC.
- Montado sobre el cuerpo de un candado Inox50.
- Diseñado para unir y proteger elementos que están a cierta distancia, gracias a su arco flexible.
- Ideal para exteriores.
- Se suministra con 2 llaves.
- Llave compatible con: cilindros Serie D; candados Inox50, Max50, K50, Armoured y Serie U; cerraduras CS125 y CS126.

- 6 mm diameter steel cable coated in PVC.
- Assembled over the body of an Inox 50 padlock.
- Designed to connect and protect components that are at a certain distance thanks to its flexible shackle.
- Ideal for outdoor use.
- Supplied with 2 keys.
- Key compatible with: D Series cylinders; Inox50, Max50, K50, Armoured Series and U Series padlocks; CS125 and CS126 locks.

## 1030



- Gran resistencia a la oxidación.
- Cuerpo de latón niquelado.
- Arco de acero inoxidable de 8 mm. de diámetro.
- Alto nivel de seguridad.
- Gran versatilidad.
- Compatible con la práctica totalidad de los medios cilindros europerfil (10/30) del mercado.
- En la gama IFAM combina con medios cilindros en leva larga de las series WX1000, M, Huno, D Y F5S.

- High resistance to rust.
- Nickel plated brass body.
- Stainless steel shackle measuring 8 mm in diameter.
- High level of security.
- Compatible with almost all Euro profile cylinders (10/30) on the market.
- Compatible with IFAM half cylinders: WX1000, M, Huno, D and F5S series.

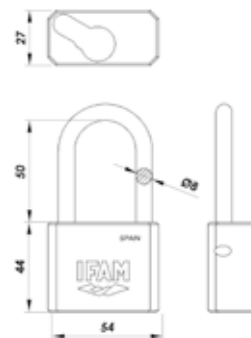
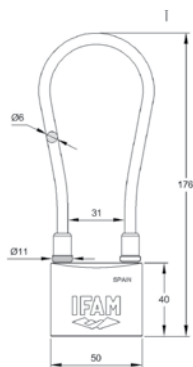
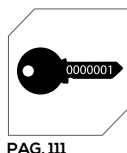
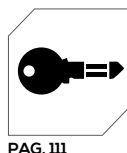

Ref.	Cod.	ICR	Pack	Uni.
Inox Cable	085051	8		6
Inox Cable KA	085055	8		6
Inox Cable KN	085057	8		6

Ref.	Cod.	ICR	Pack	Uni.
1030	056312	8		6



## Max50



- Buen nivel de seguridad. Arco protegido de 8 mm. de diámetro.
- Arco en acero inoxidable AISI303, de máxima resistencia a la corrosión.
- Cuerpo de latón extruido de alta calidad, con tratamiento antioxidación de níquel y cromo.
- Sistema de doble enganche con bolas de acero inoxidable AISI 303.
- Sistema de retención de llave con el candado abierto.
- Se suministra con 2 llaves.
- Llave compatible con: cilindros Serie D; candados Inox50, Inox Cable, K50, Serie Armoured y Serie U; cerraduras CS125 y CS126.

- Good security level. 8mm in diameter protected shackle.
- Stainless steel shackle AISI303, with maximum anti rust resistance.
- High quality extruded brass body with nickel and chrome plating treatment for rust resistance.
- Double locking system with AISI 303 stainless steel shackle.
- Supplied with 2 keys.
- Key compatible with: D Series cylinders; K50, Inox50, Inox Cable, U Series and Armoured Series padlocks; CS125 and CS126 locks.



PAG. 111

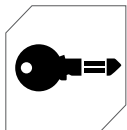

PAG. 111

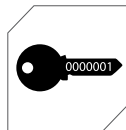

Cod. 901380



PAG. 108



PAG. 111

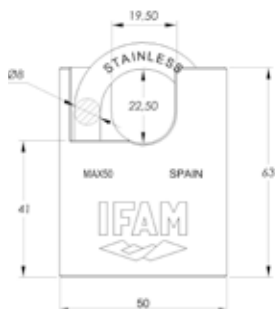

Ref.	Cod.	ICR		Pack	Uni.
Max50	045150	8			5
Max50	045151	8			6
Max50 KA	045155	8			5
Max50 Kn	045157	8			5



## Black Force



- Candado de combinación con alto nivel de seguridad
- Arco de acero de 8mm de diámetro.
- Disponible opción arco protegido contra los ataques con cizalla y palanca.
- Sistema de doble cierre de alta resistencia a la tracción.
- Cuerpo robusto de aleación de zinc.
- Sistema de doble anclaje del cuerpo con eje pasante que imposibilita la apertura por golpeo.
- Clave programable con 10.000 combinaciones diferentes.
- Disponible con o sin funda de silicona para proteger de roces el propio candado y la zona que protege. La funda se suministra con los modelos de arco protegido.
- Ideal para su uso en exteriores, gracias a su recubrimiento anticorrosión.

- Combination padlock with high level of security
- Steel shackle 8mm in diameter.
- Available with protected shackle to avoid attacks with bolt-cutter and lever.
- Double locking system with high tensile strength.
- Robust zinc alloy body.
- Double anchoring system of the body with through axle that avoids the padlock's opening by striking.
- Programmable key with 10,000 differs to choose.
- Available with or without a silicone cover to protect the padlock itself and the area it protects. The cover is supplied with the protected shackle models.
- Ideal for outdoor use, thanks to its anticorrosion coating.

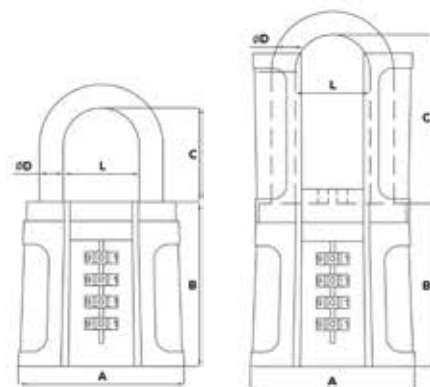

Ref.	Cod.	IPL	A	B	C	D	L	Pack	Uni.
<b>ARCO NORMAL - STANDARD SHACKLE</b>									
Black force AN	051810	8	56	56	32	8	25,5		10
<b>ARCO NORMAL PROTEGIDO - PROTECTED STANDARD SHACKLE</b>									
Black force APN	051830	8	56	56	32	8	25,5		10
<b>ARCO LARGO - PROTECTED STANDARD SHACKLE</b>									
Black force AL	051820	8	56	56	58	8	25,5		10
<b>ARCO LARGO PROTEGIDO - PROTECTED LONG SHACKLE</b>									
Black force APL	051840	8	56	56	58	8	25,5		10
<b>COMPLEMENTOS - COMPLEMENTARY PRODUCTS</b>									
Funda silicona	051840								1

## S4MK



- Candado de combinación con llave de emergencia, que permite abrir el candado en caso de olvido de la clave o si fuera necesario abrirlo sin emplear la combinación.
- Cuerpo en aleación de zinc.
- Arco de acero endurecido de 4,7 mm. de grosor (más fino que el modelo R4MK) para adaptarlo a cualquier tipo de taquilla.
- Clave programable con 4 rodillos. 10.000 combinaciones distintas.
- Llave de discos. Las llaves se venden por separado y pueden solicitarse en el punto de venta o a IFAM SEGURIDAD.

- This combination padlock with key override to open the lock in case the user forgets the combination or when is necessary to open the padlock without using the combination.
- Zinc alloy body.
- Hardened steel shackle, 4.7mm in diameter (thinner than in the R4MK model) to fit in almost every locker type.
- 4 wheel combination. 10,000 differs to choose.
- Disc type key override. Keys are sold separately. You can order them at the point of sale or by requesting them to IFAM SEGURIDAD.



PAG. III

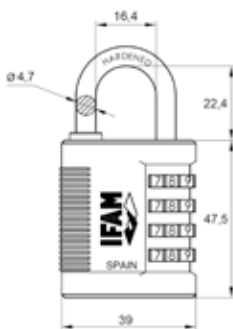

Ref.	Cod.	IPL	Pack	Uni.
S4MK KN	000688	8		7

## R4MK



- Candado de combinación con llave de emergencia, que permite abrir el candado en caso de olvido de la clave o si fuera necesario abrirlo sin emplear la combinación.
- Cuerpo en aleación de zinc.
- Arco de acero endurecido de 6,5 mm. de grosor.
- Clave programable con 4 rodillos. 10.000 combinaciones distintas.
- Llave de discos. Las llaves se venden por separado y pueden solicitarse en el punto de venta o a IFAM SEGURIDAD.
- Ideal para taquillas de gimnasios, centros deportivos, educativos, etc....

- This combination padlock with key override to open the lock in case the user forgets the combination or when is necessary to open the padlock without using the combination.
- Zinc alloy body.
- 6.5mm diameter hardened steel shackle.
- 4 wheel combination. 10,000 differs to choose.
- Disc type key override. Keys are sold separately. You can order them at the point of sale or by requesting them to IFAM SEGURIDAD.
- Suitable for gym lockers, sports centres, schools...



PAG. III

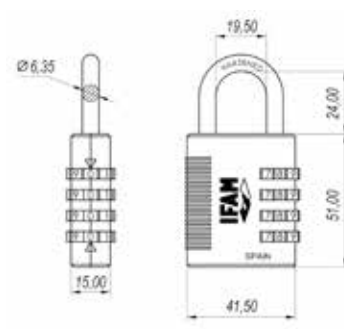

Ref.	Cod.	IPL	Pack	Uni.
R4MK KN	000690	8		7

## Hook



- Mosquetón ligero y resistente, fabricado en aleación de aluminio de 8 mm. de espesor.
- Recubierto de pintura con gran resistencia a la intemperie.
- Cierre con combinación de 4 rodillos. 10.000 combinaciones a elegir.
- Incorpora un cable para facilitar el bloqueo de elementos a distancia.
- Cable de acero trenzado recubierto de PVC: Ø 3mm y 1.2m de longitud.
- Disponible en colores rojo y negro.
- Ideal para dejar el casco asegurado a la moto, para actividades al aire libre, para mochilas, bolsos, bolsas de deporte, etc.

- A light and resistant karabiner, made in 8 mm thick alloyed aluminum.
- Covered in a weather-resistant paint.
- Lock with a 4 roller combination. 10,000 combinations to choose.
- Incorporates a cable to facilitate blocking of distant elements.
- PVC covered braided steel cable: Ø 3mm and 1.2m in length.
- Available in red and black.
- Ideal for leaving your motorcycle helmet, for outdoor activities, backpacks, bags, athletic bags, etc.

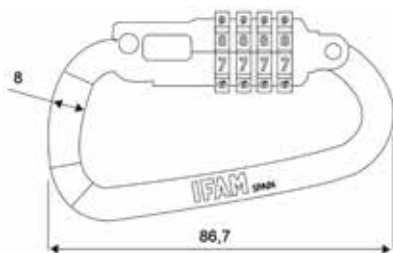

Ref.	Cl.	Cod.	IPL	Pack	Uni.
Hook	■	046680N	5	🔒	1
Hook	■	046680R	5	🔒	1

## Col Combi



- Cuerpo en aluminio, que aporta una gran ligereza a los candados.
- Dos tamaños a elegir: Col Combi 20 y Col Combi 30.
- Arco de acero cromado de 3 mm. de diámetro (Col Combi 20) y 5 mm. (Col Combi 30)
- Apertura y cierre de combinación con 3 rodillos. 1.000 combinaciones a elegir.
- Disponible en 6 colores: negro, azul, amarillo, violeta, verde y rojo.
- Ideal para taquillas de gimnasios, colegios, centros de trabajo...

- A light and resistant karabiner, made in 8 mm thick alloyed aluminum.
- Two available sizes: Col Combi 20 and Col Combi 30.
- Chromed steel shackle. Diameters: 3mm (Col Combi 20) and 5 mm (Col Combi 30).
- Lock with a 3-wheel combination. 1,000 combinations to choose.
- Available in 6 colours: black, blue, yellow, violet, green and red.
- Ideal for gym, school and workplace's lockers...



PAG. III

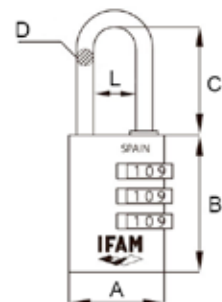

Ref.	Cl.	Cod.	A	B	C	D	E	IPL	Pack	Uni.
Col Combi 20	■	000612A	21	30	21	3	9,5	5	🔒	6
Col Combi 20	■	000612B	21	30	21	3	9,5	5	🔒	6
Col Combi 20	■	000612N	21	30	21	3	9,5	5	🔒	6
Col Combi 20	■	000612R	21	30	21	3	9,5	5	🔒	6
Col Combi 20	■	000612P	21	30	21	3	9,5	5	🔒	6
Col Combi 20	■	000612V	21	30	21	3	9,5	5	🔒	6
Col Combi 30	■	000614A	28	41	27,5	5	13	5	🔒	6
Col Combi 30	■	000614B	28	41	27,5	5	13	5	🔒	6
Col Combi 30	■	000614N	28	41	27,5	5	13	5	🔒	6
Col Combi 30	■	000614R	28	41	27,5	5	13	5	🔒	6
Col Combi 30	■	000614P	28	41	27,5	5	13	5	🔒	6
Col Combi 30	■	000614V	28	41	27,5	5	13	5	🔒	6

## Serie CS - CS Series



- Cuerpo de aleación de zinc obtenida mediante fundición inyectada de alta precisión.
- Arco endurecido y cromado.
- Capa protectora especial de pintura y lateral ergonómico en PVC.
- Especialmente indicado para equipajes, material deportivo, instalaciones deportivas, etc.
- C25S Cable: candado C25S con cable de 1 m. de longitud aprox, ideal para asegurar varios elementos a la vez.

- Zinc alloy body obtained using high precision die-cast.
- Hardened and chrome plated shackle.
- Coat of special protective paint and ergonomic PVC side.
- Specially indicated for luggage, sport bags, sports facilities, etc.
- C25S Cable: C25S padlock with a 1 meter long approx. cable, ideal for securing several items at the same time.



PAG. III

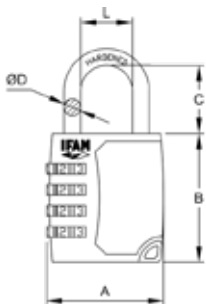

Ref.	Cod.	IPL	A	B	C	D	L	Pack	Uni.
C25S	000680	6	26	31,5	14,5	3	9		6
C25S Cable	000680C	6	26	31,5	14,5	3	9		6
C35S	000682	6	34,5	37	19,5	4,7	14		6
C45S	000684	6	44,5	49	26	6,3	19,5		6

## Serie CR - CR Series



- Cuerpo de latón.
- Arco de acero cromado.
- Programación con 3 rodillos (1.000 combinaciones a elegir) en los candados C20R y C30R.
- Programación con 4 rodillos (10.000 combinaciones posibles) en el candado C40R.

- Brass body.
- Chromed steel shackle.
- 3-dial combinations (1.000 differs) in the C20R and C30R padlocks.
- 4-dial combination (10.000 differs) in the C40R padlock.



PAG. III

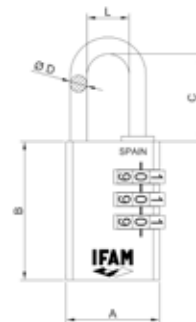

Ref.	Cod.	IPL	A	B	C	D	L	Pack	Uni.
C20R	000615	6	21	30	22,5	3	9		12
C30R	000617	6	28	41,5	26	5	12,7		6
C40R	000619	6	38	49	30,2	6,3	19		6



## TrypLock35



- Especial para equipajes en viajes a EE.UU.
- Indicador que permite conocer si el candado ha sido abierto en la aduana para la inspección del equipaje.
- Cumple con la norma TSA y permite al servicio de seguridad de los aeropuertos de EE.UU. abrir y cerrar la maleta para su inspección sin dañar ni el equipaje ni el candado.

- Designed for travelling to the United States.
- Includes an indicator that allows knowing if the padlock has been opened by the U.S. customs for inspection.
- Complies with TSA regulations and allows the US airport security service to open and close the bag for inspection without damaging the luggage or lock.



PAG. 111

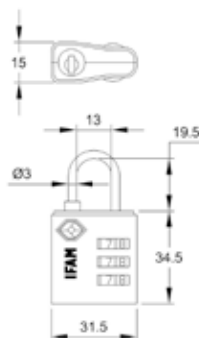

Ref.	Cod.	IPL	Pack	Uni.
TrypLock35	000677	5		6

## TrypLock 4W

N



- Candado especial para equipajes en viajes a EEUU.
- Cuerpo en aleación de zinc.
- Arco de acero endurecido de 4mm de diámetro.
- Cierre con combinación de 4 rodillos para una mayor seguridad. 10.000 combinaciones posibles.
- Cumple con la norma TSA y permite al servicio de seguridad de los aeropuertos de EE.UU. abrir y cerrar la maleta para su inspección sin dañar el equipaje ni el candado.

- A special baggage lock for travel to the USA.
- Zinc alloy body.
- Hardened steel shackle with a diameter of 4 mm.
- Four 10-digit wheel combination lock for greater security. 10,000 combinations to choose.
- Complies with TSA regulations and allows the US airport security service to open and close the bag for inspection without damaging the luggage or lock.



PAG. 111

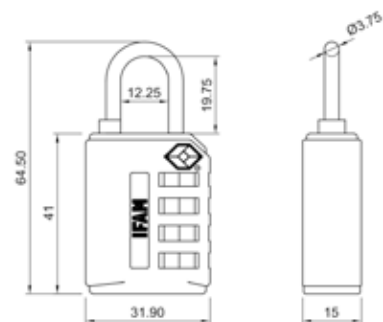

Ref.	Cod.	IPL	Pack	Uni.
TrypLock 4W	000678G	6		5

## TrypLock Cable

N



- Candado especial para equipajes en viajes a EEUU.
- Arco con cable flexible de acero trenzado con cobertura plástica.
- Diámetro de arco: 3mm.
- Cuerpo en aleación de zinc.
- Cierre con combinación de 3 rodillos. 1.000 combinaciones posibles.
- Incorpora una lupa lateral para facilitar la visualización de los números de los rodillos.
- Cumple con la norma TSA y permite al servicio de seguridad de los aeropuertos de EE.UU. abrir y cerrar la maleta para su inspección sin dañar el equipaje ni el candado.

- A special baggage lock for travel to the USA.
- Shackle with a flexible braided steel cable covered in plastic.
- Shackle diameter: 3mm.
- Zinc alloy body.
- Three 10-digit wheel combination lock. 1,000 combinations to choose.
- Magnifying glass on the side to more easily see the wheel numbers.
- Complies with TSA regulations and allows the US airport security service to open and close the bag for inspection without damaging the luggage or lock.



PAG. 111

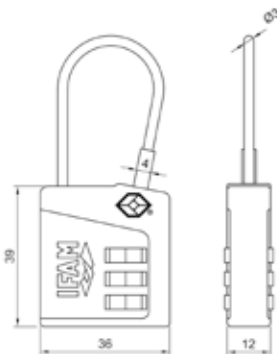

Ref.	Cod.	IPL	Pack	Uni.
TrypLock Cable	000679B	6	1	5

## Circular Combi

N



- Cuerpo de acero inoxidable.
- Arco protegido anticizalla.
- Apertura y cierre de combinación con 4 rodillos. 10.000 combinaciones a elegir.
- Especialmente indicado para exteriores y zonas a la intemperie: mobiliario urbano, contenedores, verjas...

- Stainless steel body.
- Bolt-cutter proof shackle.
- 4-dial combination locking: 10,000 differs to choose.
- Specially designed for outdoors and areas exposed to the elements: street furniture, containers, gates, etc.
- Supplied with 2 keys.



PAG. 111

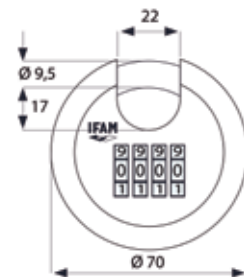

Ref.	Cod.	IPL	Pack	Uni.
Circular Combi	000552	8	1	6

### Cool Touch

N



- Candado de apertura táctil. Funciona con la huella dactilar del usuario.
  - Capacidad para registrar las huellas de hasta 10 usuarios diferentes, habilitados por el usuario principal (administrador).
  - Apertura instantánea, en menos de 1 segundo.
  - Cuerpo en aleación de zinc.
  - Arco fabricado en acero. Diámetro: 4mm.
  - Batería de gran duración: 2.500 ciclos de apertura y cierre.
  - Incluye cargador de batería USB-C, de carga ultra rápida.
  - Ideal para su uso en taquillas, maletas, mochilas...  
Peso muy ligero: 85 gr.
  - Válido para uso en interiores y exterior. Grado de protección a la intemperie IP65 (no sumergible).
  - Temperatura de uso entre -10 y 45°C.
- Touch opening padlock. Operates with user's fingerprint.
  - Ability to register fingerprints of up to 10 different users, enabled by the main user (administrator).
  - Instant opening in less than 1 second.
  - Body manufactured in zinc alloy.
  - 4mm steel shackle.
  - Long battery life: 2,500 open and close cycles.
  - Includes USB-C battery charger for ultra-fast charging.
  - Ideal for lockers, suitcases, backpacks, etc. Very light weight: 85 gr.
  - For indoor and outdoor use. IP65 weather protection rating (non-submersible).
  - For use in temperatures between -10C and 45C.



PAG. 111

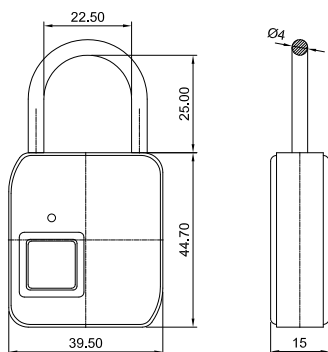

Ref.	Cod.	IPL	Pack	Uni.
Cool Touch	000660	8		10

### Mag40



- Candado magnético.
  - Sistema antisabotaje de apertura con llave magnética.
  - Diseño exclusivo y diferenciado.
  - Arco de acero endurecido y cromado.
  - Sistema antisuciedad y antiganzúa sin orificio de ataque.
  - Se suministra con 2 llaves.
- Magnetic padlock.
  - Anti-sabotage system that opens with a magnetic key.
  - An exclusive and different design.
  - Hardened and chrome plated steel shackle.
  - Dirt and pick proof system.
  - Supplied with 2 keys.

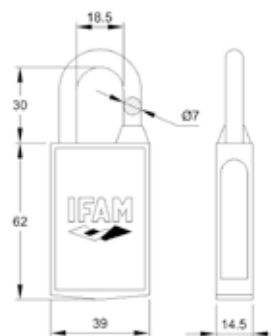

Ref.	Cod.	IPL	Pack	Uni.
Mag40	000650	7		6



## Circular



- Cuerpo de acero inoxidable.
- Arco protegido anticizalla.
- Extracción de la llave sólo en posición de cerrado.
- Especialmente indicado para exteriores y zonas a la intemperie: mobiliario urbano, contenedores, verjas...
- Se suministra con 2 llaves.

- Stainless steel body.
- Bolt-cutter proof shackle.
- Key retaining.
- Specially designed for outdoors and areas exposed to the elements: street furniture, containers, gates, etc.
- Supplied with 2 keys.



PAG. III

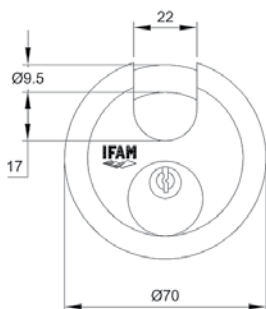

Ref.	Cod.	IPL		Pack	Uni.
Circular	000550	8			6
Circular KN	000557	8			6

## Rhin



- Candado tipo alemán.
- Cuerpo de latón fundido.
- Arco de acero endurecido.
- Diámetro de arco: 8 mm.
- Se suministra con 2 llaves.

- German type padlock.
- Cast brass body.
- Hardened steel shackle.
- Shackle diameter: 8 mm.
- Supplied with 2 keys.



PAG. III

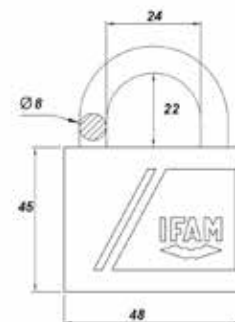

Ref.	Cod.	IPL		Pack	Uni.
Rhin 40	018400	7			6
Rhin 40 KN	018407	7			6

### Láminas - Laminated



- Cuerpo de láminas de acero endurecido.
  - Cierre de doble enganche.
  - Protección antigolpes.
  - Diseñado para su uso en taquillas de centros deportivos y educativos, exteriores.
  - Se suministra con 2 llaves.
- Hardened steel laminated body.
  - Double locking mechanism.
  - Protection against impacts.
  - Specially designed for use in lockers at sports centres and schools, outdoor places...
  - Supplied with 2 keys.



PAG. 111

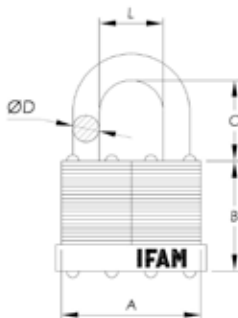

### WP45



- Cuerpo de láminas de acero recubierto por una funda termoplástica hermética.
  - Arco de acero endurecido y cromado con cubierta termoplástica.
  - Tapa aislante para protección del cilindro.
  - Especialmente indicado para exteriores y zonas a la intemperie: WP (Weather Proof).
  - Se suministra con 2 llaves.
- Hardened steel laminated body protected by a hermetic thermoplastic casing.
  - Hardened steel chromed shackled covered by a thermoplastic casing.
  - Cylinder protected by an isolating lid.
  - Specially recommended for outdoors: WP (Weather Proof).
  - Supplied with 2 keys.



PAG. 111

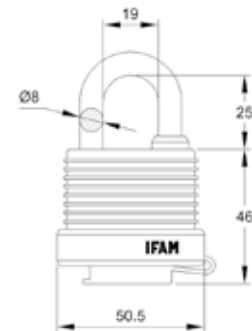

Ref.	Cod.	IPL	A	B	C	D	L		Pack	Uni.
LM30	044330	6	31	21	17	5	14			6
LM30 KN	044335	6	31	21	17	5	14			6
LM40	044340	6	41	34	22	6,5	20			6
LM40 KN	044345	6	41	34	22	6,5	20			6
LM50	044350	6	50	39	29	9,5	22,5			6
LM50 KN	044355	6	50	39	29	9,5	22,5			6
LM65	044360	6	60,5	44	31,5	11	28			6
LM65 KN	044365	6	60,5	44	31,5	11	28			6

Ref.	Cl.	Cod.	IPL		Pack	Uni.
WP45		044501A	6			6
WP45		044501B	6			6
WP45 KN		044507Bn	6			6
WP45		044501R	6			6
WP45 KN		044507Rn	6			6
WP45		044501V	6			6

## GunLock



- Diseñado para pistolas, escopetas, rifles y carabinas, previniendo su uso no autorizado.
- Cuerpo de fundición inyectada con funda plástica protectora.
- Se suministra con 2 llaves, una de ellas con led luminoso para facilitar su apertura en la oscuridad.

- Designed for guns, rifles and carbines to prevent unauthorised use.
- Die-cast body protected by a plastic cover.
- Supplied with 2 keys; one of them with LED to help opening at night.

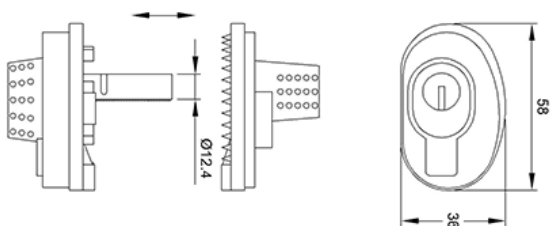

Ref.	Cod.	IPL	Pack	Uni.
Gun Lock	020107	8		10



## PC410 / PC420 / PC430



- Portacandados fabricado en acero estampado con argolla de sujeción endurecida.
- Espesor del herraje: PC410 (4 mm.), PC420 (5 mm.), PC430 (4 mm.)
- Tornillos de fijación ocultos. Fácil montaje.
- Complementan a los candados en la protección de áreas que no disponen de un acople especial para colocarlos.

- Manufactured in stamped steel with hardened fastening ring.
- Hardware thickness: PC410 (4 mm.), PC420 (5 mm.), PC430 (4 mm.)
- Hidden fixing bolts. Easy installation.
- Used with padlocks to protect areas that do not have a special coupling to install them.

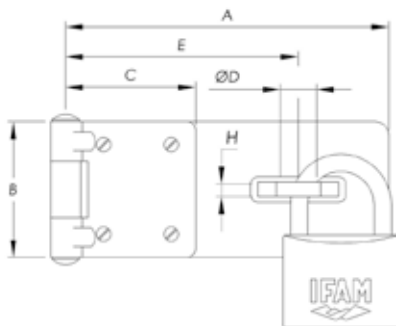

Ref.	Cod.	IPL	A	B	C	D	E	Pack	Uni.
PC410	000410	6	73	29	28	9,5	53		6
PC420	000420	7	112	47	45	13	81		6
PC430	000430	7	131	47	45	13	100		6

## PCL2



- Portacandados fabricado en acero estampado y endurecido.
- Baño de níquel para hacerlo resistente a la corrosión.
- Combinable con candados de arco de hasta 14,5 mm. de diámetro.
- Diseñado para colocarse en portones, puertas de seguridad, camiones, remolques, contenedores...

- Hasp manufactured in stamped and hardened steel.
- Nickel plated making it resistant to corrosion.
- Valid for shackle locks measuring 14.5 mm in diameter.
- Designed for installation on gates, safety doors, trucks, trailers, containers, etc.

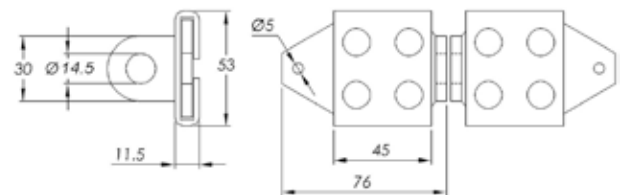

Ref.	Cod.	IPL	Pack	Uni.
PCL2	000458	8		6

## PS455



- Herraje y tornillos en acero carbonitrurado y cincado.
- Tornillos con diseño anticizalla y antitaladro.
- Tornillos DIN 603x63 mm. de longitud.
- Apto para espesor de puerta de 40 mm.
- Espesor del herraje: 5 mm.
- Concebido para ser colocado en combinación con candados de alta seguridad.

- Fittings and bolts made of carbon-nitrate and zinc plated steel.
- Bolts protected against bolt-cutters and drills.
- DIN 603x63 mm long bolts.
- Suitable for doors with a thickness of 40 mm.
- Hardware thickness: 5 mm.
- Designed to be installed in conjunction with high security padlocks.

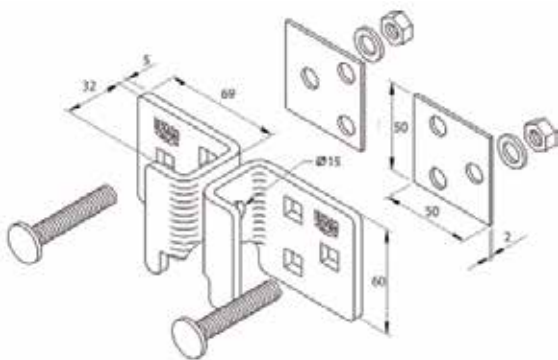

Ref.	Cod.	IPL	Pack	Uni.
PS455	000455	8		5

## PCH1



- Fabricado en acero estampado y endurecido.
- Baño de níquel para hacerlo resistente a la corrosión.
- Espesor del herraje: 4 mm.
- Combinable con candados de arco de hasta 13 mm. de diámetro.
- Especialmente indicado para cierres de rejas de movimiento horizontal.

- Manufactured in stamped and hardened steel.
- Nickel plated making it resistant to corrosion.
- Hardware thickness: 4 mm.
- Suitable for padlocks with shackle measuring up to 13 mm in diameter.
- Especially designed for locking horizontal moving gates and fences.

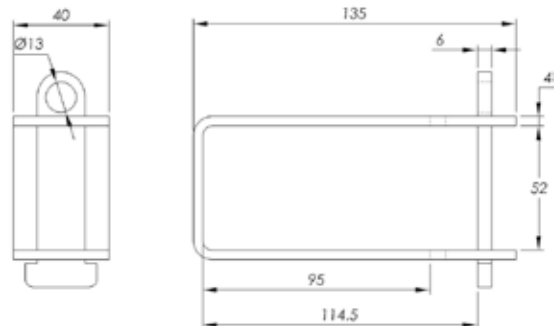

Ref.	Cod.	IPL	Pack	Uni.
PCH1	000471	7		6







## SEGURIDAD INDUSTRIAL INDUSTRIAL SAFETY

**CANDADOS  
LOTO  
LOTO  
PADLOCKS**



PAG. 72

**PINZAS  
LOTO  
LOTO  
HASP & STAPLES**



PAG. 75

**BLOQUEO  
MECÁNICO  
MECHANICAL  
LOCKOUT**



PAG. 76

**BLOQUEO  
ELÉCTRICO  
ELECTRIC  
LOCKOUT**



PAG. 76

**OTROS PRODUCTOS  
LOTO  
OTHER LOTO  
PRODUCTS**



PAG. 78

## SF40

- Cuatro tipos de arco disponibles: acero tratado, acero inoxidable, nylon, cable.
  - SF40 con arco de acero o acero inoxidable: resistente a los impactos, rayos ultravioleta, corrosión y temperaturas extremas. Indicado para seguridad del personal en instalaciones peligrosas.
  - SF40 con arco de nylon: resistente a los impactos, rayos ultravioleta, corrosión y temperaturas extremas. Candado antichispa, dieléctrico, ideal para la industria química, minería, instalaciones militares y energéticas y entornos inflamables o explosivos.
  - SF40 cable: resistente a impactos, rayos ultravioleta, corrosión y temperaturas extremas. Diámetro del cable 3,4 mm ideal para bloquear equipos con orificios máximos de 6,5mm donde el acceso al bloqueo sea complicado y el cable pueda facilitar el acceso.
  - Cuerpo fabricado en polímero altamente aislante ABS.
  - Sistema de retención de llave con el candado abierto.
  - Incluye pegatinas para señalización de la zona peligrosa que el candado protege.
  - Se suministra con 1 llave. Llave compatible con candados Col40.
  - 6 colores disponibles: rojo, azul, verde, amarillo, negro y naranja.
- 
- Four types of shackle to choose: steel, stainless steel, nylon or steel cable.
  - SF40 with steel or stainless steel shackle: shock, UV-ray, corrosion and extreme temperature resistant. Suitable for the safety of the personnel in hazardous facilities.
  - SF40 with nylon shackle: shock, UV-ray, corrosion and extreme temperature resistant. Antisparking, dielectric padlock. Suitable for using in chemical industry, military and power facilities and inflammable and explosive environments.
  - SF40 with cable shackle: made from stainless steel, shock, UV-ray, corrosion and extreme temperature resistant. Cable diameter of 3.4 mm. This padlock is ideal for blocking lockout devices with holes up to 6.5mm in diameter and for being used in places where blocking industrial equipment is complicated due to lack of space.
  - Body made of highly insulating polymer ABS.
  - Key retention system when the padlock is open.
  - Includes stickers for signaling the danger zone protected by the padlock.
  - Supplied with 1 key. Key compatible with Col40 padlocks.
  - 6 colors available: red, blue, green, yellow, black and orange.



Cod. 900860

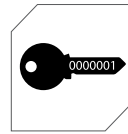
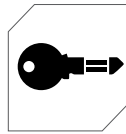

Cod. 901060



Cod. 901390

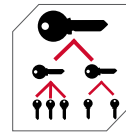

Cod. 901590

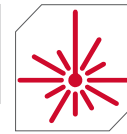

PAG. 111



PAG. 108

Ref.	Cl.	Cod.	A	B	C	D	L		Pack	Uni.
<b>ARCO NORMAL ACERO - STEEL STANDARD SHACKLE</b>										
SF40 AN	■	044700	40	27	38	6	15,5			10
SF40 AN	■	044740	40	27	38	6	15,5			10
SF40 AN	■	044780	40	27	38	6	15,5			10
SF40 AN	■	044820	40	27	38	6	15,5			10
SF40 AN	■	044860	40	27	38	6	15,5			10
SF40 AN	■	044900	40	32	38	6	23			10

Ref.	Cl.	Cod.	A	B	C	D	L		Pack	Uni.
<b>ARCO NORMAL ACERO INOXIDABLE - STAINLESS STEEL STANDARD SHACKLE</b>										
SF40 IN	■	044710	40	32	38	6	23			10
SF40 IN	■	044750	40	32	38	6	23			10
SF40 IN	■	044790	40	32	38	6	23			10
SF40 IN	■	044830	40	32	38	6	23			10
SF40 IN	■	044870	40	32	38	6	23			10
SF40 IN	■	044910	40	32	38	6	23			10



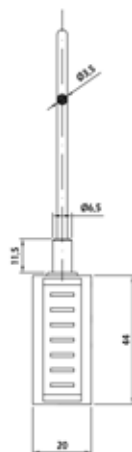
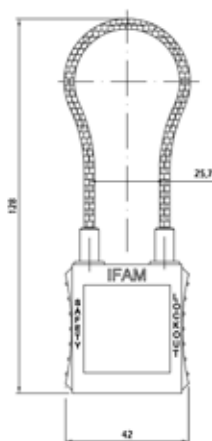
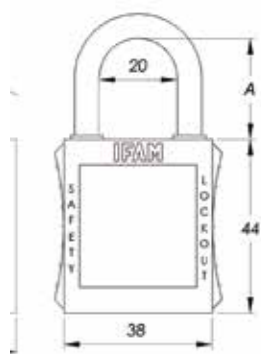

Ref.	Cl.	Cod.	A	B	C	D	L	Pack	Uni.	
<b>ARCO NORMAL NYLON - NYLON STANDARD SHACKLE</b>										
SF40 PN	■	044720	40	40	38	6	29			10
SF40 PN	■	044760	40	40	38	6	29			10
SF40 PN	■	044800	40	40	38	6	29			10
SF40 PN	■	044840	40	45	38	6	35			10
SF40 PN	■	044880	40	45	38	6	35			10
SF40 PN	■	044920	40	45	38	6	35			10

Ref.	Cl.	Cod.	A	B	C	D	L	Pack	Uni.	
<b>ARCO LARGO NYLON - NYLON LONG SHACKLE</b>										
SF40 PL	■	044726	40	32	72	6	23			10
SF40 PL	■	044766	40	32	72	6	23			10
SF40 PL	■	044806	40	40	72	6	29			10
SF40 PL	■	044846	40	40	72	6	29			10
SF40 PL	■	044886	40	40	72	6	29			10
SF40 PL	■	044926	40	40	72	6	29			10

<b>ARCO CABLE - CABLE SHACKLE</b>										
Ref.	Cl.	Cod.	A	B	C	D	L	Pack	Uni.	
SF40 Cable	■	044950	38	44	80	3,5	37,5			10
SF40 Cable	■	044951	38	44	80	3,5	37,5			10
SF40 Cable	■	044952	38	44	80	3,5	37,5			10
SF40 Cable	■	044953	38	44	80	3,5	37,5			10

## Col40



- Cuerpo de aluminio anodizado y arco de acero endurecido.
  - Cilindro intercambiable con los candados SF40.
  - Disponible en cuatro colores diferentes.
  - Adecuado como elemento de seguridad y señalización en trabajos de mantenimiento e instalaciones productivas.
  - Sistema de retención de llave con el candado abierto.
  - Se suministra con 2 llaves.
  - Llave compatible con candados SF40.
- Anodized aluminium body and hardened steel shackle.
  - Interchangeable cylinder with all the SF40 padlock's versions.
  - Available in four different colours.
  - Suitable as a security and signal element for maintenance and production installations.
  - Key retention system when the padlock is open.
  - Supplied with 2 keys. Compatible key with SF40 padlocks.

## K40AB75



- Cuerpo y arco de latón especial.
  - Diseñado para industrias y ambientes con sustancias altamente inflamables.
  - Sistema automático de doble enganche.
- Special brass body and shackle.
  - Designed for industries and environments with highly flammable substances.
  - Automatic double locking system.

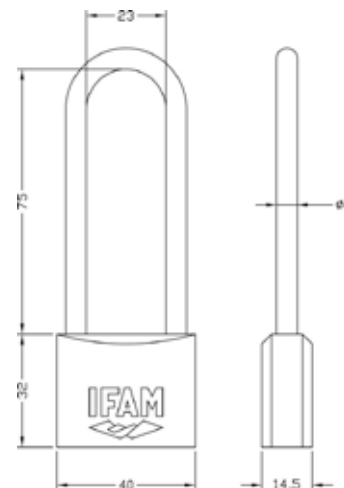
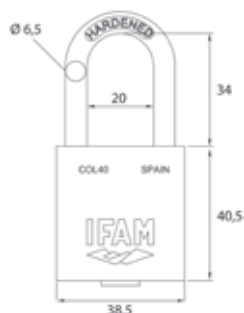
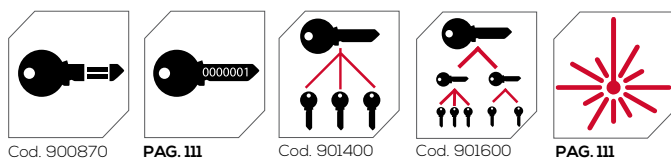

Ref.	Cl.	Cod.		Pack	Uni.
COL40B		044600B			6
COL40B KN		044607B			6
COL40N		044600N			6
COL40N KN		044607N			6
COL40R		044600R			6
COL40R KN		044607R			6
COL40V		044600V			6
COL40V KN		044607V			6

Ref.	Cod.		Pack	Uni.
K40AB75	014050			12
K40AB75 KA	014050			12
K40AB75 KN	014050			12

## Pinzas dieléctricas

Dielectric hasps

N



- Fabricadas en polipropileno especialmente tratado para hacerlas resistentes a la degradación producida por agentes químicos.
- Totalmente dieléctricas, ideales para bloquear la fuente de alimentación eléctrica de maquinaria y equipos industriales.
- Uso muy sencillo. Se abren y se cierran deslizando la pestaña central.
- Se bloquean con hasta 4 candados LOTO, por lo que son ideales para tareas de consignación llevadas a cabo por equipos de varias personas. Hasta que no se retira el último candado, la máquina o equipo permanecen bloqueados por estos dispositivos.
- Dos diámetros de arco disponibles: 3mm y 6 mm.

- Manufactured in polypropylene specially treated for higher resistance to degradation produced by chemical agents.
- Fully dielectric, ideal for blocking the power supply of industrial machinery and equipment.
- Very simple use. Open and close operation by sliding the central tab.
- They can be locked with up to 4 LOTO padlocks. Ideal for lockout-tagout teams. Until the last padlock is removed by one member of the team, the machine or equipment will remain blocked by these devices.
- Two available shackle diameters: 3mm and 6mm.



PAG. III

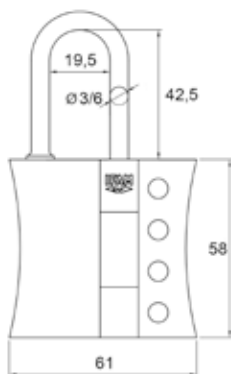

## Port. Múltiple Aluminio

Flameproof alum. hasp lockout



- Diseñado para ser colocado en interruptores de alimentación, cuyo manejo debe ser restringido para evitar un uso accidental del equipo.
- Mordaza en aluminio con tratamiento ignífugo con mango revestido en resina de aislamiento. Puede utilizarse en ambientes con riesgo químico o por altas temperaturas de uso.
- 2 diámetros interiores de mordaza a elegir: 25,4 y 38 mm.
- Capacidad para colocar hasta 6 candados simultáneamente con diámetros de arco de hasta 9 mm.
- Compatible con cualquier candado de la Serie Safety de IFAM (SF40, Col40, K40AB75).

- Designed to be placed in power switches, whose management should be restricted to prevent accidental use of the equipment.
- Fireproof aluminum grip with insulating resin coated handle. It can be used in environments with chemical risk or high temperatures of use.
- 2 grip inner diameters to choose: 25.4 and 38 mm.
- Capacity to simultaneously place up to 6 padlocks with shackle diameters up to 9 mm.
- Compatible with any padlock on the IFAM Safety Series (SF40, Col40, K40AB75).

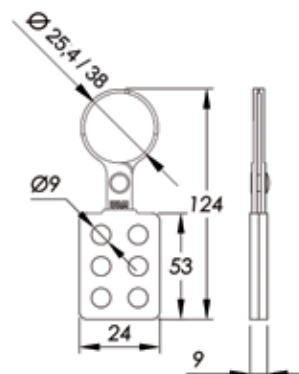

Ref.	Cod.	Pack	Uni.
Pinza dieléctrica Ø3 Dielectric hasp Ø3	090170		10
Pinza dieléctrica Ø6 Dielectric hasp Ø6	090180		10

Ref.	Cod.	Pack	Uni.
Port. Múltiple Aluminio Ø 25,4 Flameproof aluminium hasp lockout Ø 25,4	090110		10
Port. Múltiple Aluminio Ø 38 Flameproof aluminium hasp lockout Ø 38	090120		10

## Port. Múltiple Cable Ø4

Cable lockout Ø 4



- Dispositivo con cable separado del cuerpo para una mayor facilidad de uso.
- Cable de acero trenzado de 4mm de espesor y 3m de longitud.
- Dispositivo separado de plástico de color rojo para hacerla fácilmente identificable. Resistente a impactos, altas temperaturas, corrosión y rayos UVA.
- Bloqueo con hasta 6 candados con un diámetro máximo de 7mm.

- Device with cable separated from the body for an easier and more comfortable use.
- Stranded steel cable 4mm thick and 3m long.
- Separate plastic device painted red to make it easily identifiable. Resistant to impacts, high temperatures, corrosion and red UVA rays.
- Locking with up to 6 padlocks with shackle diameter up to 7mm.

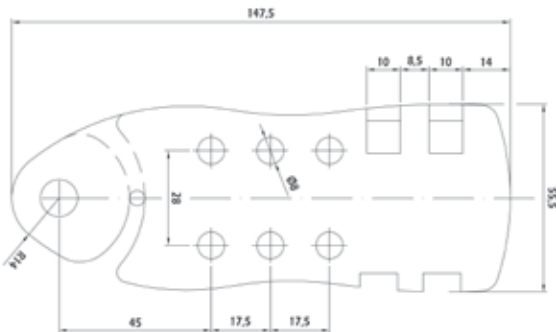

Ref.	Cod.	Pack	Uni.
Portacandados Múltiple Cable Ø 4 Cable lockout Ø 4	090298		5

## Port. Múltiple Cable Ø 6

Cable lockout Ø 6



- Portacandados ideal para proteger paneles de múltiples disyuntores y bloqueadores de válvulas ubicados unos unto a otros.
- Dispositivo ergonómico de polietileno para facilitar el ajuste del cable.
- Cable de acero trenzado resistente y a la vez flexible para facilitar el ajuste. Revestimiento de plástico transparente para evitar la corrosión ambiental y la producida por agentes químicos.
- Diámetro del cable: 6 mm. Longitud del cable: 2 metros.
- Capacidad de hasta 4 candados de 8mm máximo de grosor de arco.
- Incluye pegatinas para señalización de la zona peligrosa protegida.
- Compatible con cualquier candado de la Serie Safety de IFAM (SF40, Col40, K40AB75).

- Ideal for protecting multiple circuit breaker panels and block valves located next to each other.
- Ergonomic polyethylene device for easy adjustment of the cable.
- Resistant and flexible braided steel cable flexible for easy adjustment. Transparent plastic coating to prevent the corrosion produced by the environment and chemical agents.
- Cable diameter: 6 mm. Cable length: 2 m.
- Ability to place up to 4 padlocks with 8mm maximum shackle diameters.
- Stickers included for signaling the danger zone protected by the hasp.
- Compatible with any padlock from the Safety Series of IFAM (SF40, Col40, K40AB75).

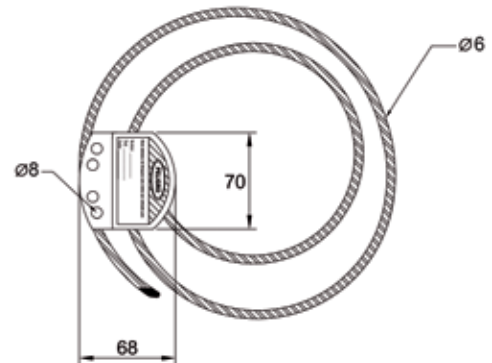

Ref.	Cod.	Pack	Uni.
Port. Múltip. Cable Ø 6 Cable lockout Ø 6	090300		5

## Bloq. interrup. magnetot.

Thermal-magnetic circuit breaker lockouts

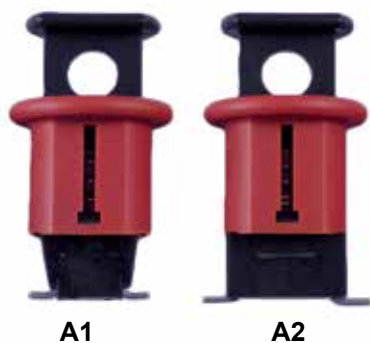

- Dispositivos diseñados para bloquear interruptores magnetotérmicos en un cuadro de mandos.
  - Fabricados en nylon con carga de fibra de vidrio al 30% para dotarlos de mayor resistencia.
  - Pasadores y tornillos de acero inoxidable.
  - Resistentes a las sustancias químicas y temperaturas extremas.
  - Disponibles para interruptores individuales y multipolares.
  - Ajuste mediante sistema de pulsador / tirador. No se precisan herramientas adicionales.
  - Bloqueo mediante un candado con diámetro de arco máximo de 6 mm.
- Devices designed to lockout thermal-magnetic switches on a control panel.
  - Made from nylon and 30% fibreglass for added resistance.
  - Stainless steel bolts and screws.
  - Resistant to chemical substances and extreme temperatures.
  - Available for individual and multipolar switches.
  - Adjustable with button or handle. No additional tools required.
  - Lockable with padlocks with shackle diameter up to 6mm.

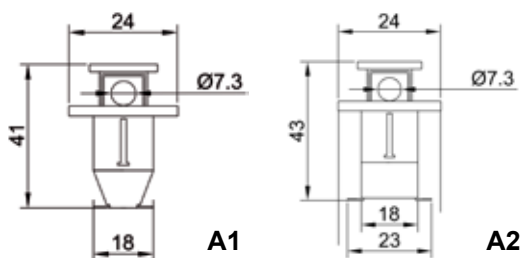

Ref.	Cod.	Pack	Uni.
Bloqueo para interruptor magnetotérmico A1 Thermal-magnetic circuit breaker lockout A1	090200		10
Bloqueo para interruptor magnetotérmico A2 Thermal-magnetic circuit breaker lockout A2	090220		10

## Bloq. magnetotérmico de eje

Thermal-magnetic circuit breaker axis lockouts

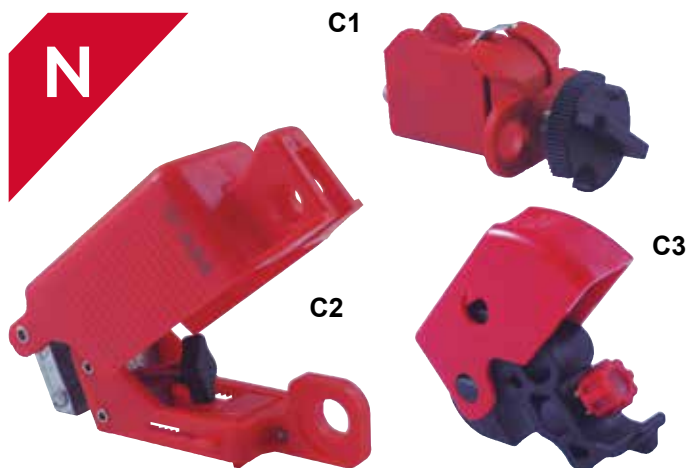

- Dispositivos diseñados para bloquear interruptores de diferentes tamaños en un cuadro de mandos.
  - Fabricados en nylon con carga de fibra de vidrio al 30% para dotarlos de mayor resistencia.
  - Pasadores y tornillos de acero inoxidable.
  - Resistentes a las sustancias químicas y temperaturas extremas.
  - Disponibles para interruptores individuales y multipolares.
  - Ajuste mediante sistema de tornillo.
  - Bloqueo mediante un candado con diámetro de arco máximo de 6 mm.
- Devices designed to block switches of different sizes on a distribution panel.
  - Made of nylon with 30% fiberglass load for greater strength.
  - Stainless steel pins and bolts.
  - Resistant to chemicals and extreme temperatures.
  - Available for single and multi-pole switches.
  - Adjustment by screw system.
  - Lockable with padlocks with shackle diameter up to 6mm.

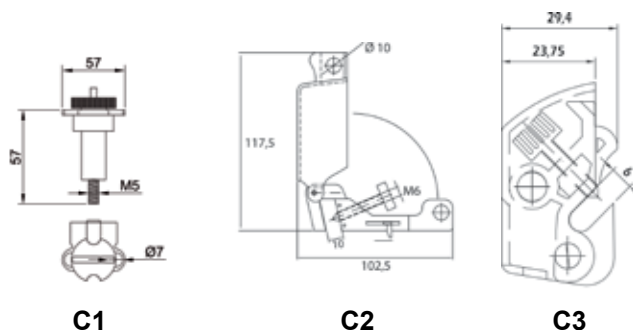

Ref.	Cod.	Pack	Uni.
Bloqueo para interr. magnetotérmico eje C1 Thermal-magnetic circuit breaker axis lockouts C1	090230		10
Bloqueo para interr. magnetotérmico eje C2 Thermal-magnetic circuit breaker axis lockouts C2	090232		10
Bloqueo para interr. magnetotérmico eje C3 Thermal-magnetic circuit breaker axis lockouts C3	090231		10

## Bloq. válvulas de compuerta

### Gate valve lockouts



- Diseñados en 5 tamaños diferentes para adaptarse a cualquier tipo de válvula de compuerta: Ø 65 mm., Ø 130 mm., Ø 170 mm., Ø 255 mm., Ø 330 mm.
  - Fabricados en polímero ABS, altamente resistente a los impactos y al desgaste por abrasión.
  - Resistente a temperaturas entre -40°C y 180° C.
  - Bloqueo mediante un candado con diámetro de arco máximo de 8,5 mm.
  - Incluyen etiquetas adhesivas de señalización de la válvula protegida por el sistema de bloqueo.
- Designed in five different sizes to suit any kind of gate valve: Ø 65 mm, Ø 130 mm, Ø 170 mm, Ø 255 mm and Ø 330 mm.
  - Made from high impact and abrasion wear resistant ABS polymer.
  - Resistant to temperatures between -40°C and 180°C.
  - Lockable with a padlock with shackle diameter up to 8.5mm.
  - Includes marking stickers for the valve protected by the locking device.

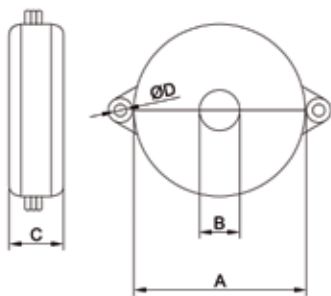

Ref.	Cod.	A	B	C	D	Pack	Uni.
Bloqueo válvulas compuerta 25-64 Gate valve lockout 25-64	090340	65	15	30	9		6
Bloqueo válvulas compuerta 64-127 Gate valve lockout 64-127	090350	130	40	40	9		3
Bloqueo válvulas compuerta 127-165 Gate valve lockout 127-165	090360	170	65	45	9		3
Bloqueo válvulas compuerta 165-254 Gate valve lockout 165-254	090370	255	90	60	9		1
Bloqueo válvulas compuerta 254-330 Gate valve lockout 254-330	090380	330	95	70	9		1

## Bloqueo válvulas 1/4 vuelta

### 1/4 turn valve lockouts



- Diseñados para bloquear la llave de paso de accionamiento de válvulas de 1/4 de vuelta.
  - Fabricados en poliamida altamente resistente a los golpes y el desgaste. También posee una alta capacidad aislante a las temperaturas extremas.
  - Disponibles en 2 tamaños:
    - Para llaves de paso entre 6,5 y 65 mm. o tuberías de diámetros entre 14,5 y 52,5 mm.
    - Para llaves de paso hasta 205 mm. o tuberías con diámetros entre 50 y 200 mm.
  - Resistente a temperaturas entre -40°C y 180° C.
  - Bloqueo con hasta 3 candados con diámetro de arco máximo de 8,5 mm.
- Designed to lock the stopcocks on various 1/4 turn valves.
  - Made from high performance polyamide an extremely impact and wear resistant material. It also has high insulation strength against extreme temperatures.
  - Available in two sizes:
    - For stopcocks between 6.5 and 65mm or pipes with diametres between 14.5 and 52.5mm
    - For stopcocks up to 205 mm. or pipes with diametres between 50 and 200mm.
  - Resistant to temperatures between -40°C and 180°C.
  - Lockable with up to three padlocks with shackle diameter ip to 8.5mm.

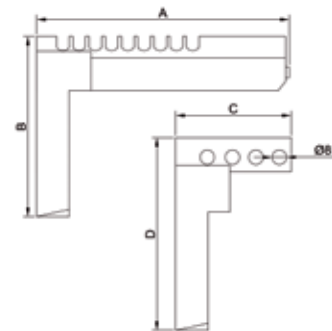

Ref.	Cod.	A	B	C	D	Pack	Uni.
Bloqueo válvulas 1/4 vuelta A1 1/4 turn valve lockout A1	090320	140	100	64	105		2
Bloqueo válvulas 1/4 vuelta A2 1/4 turn valve lockout A2	090330	305	215	115	220		2

## Bloq. válvulas brazo doble

Valve lockout with double blocking arm

N



- Diseñado para bloquear la llave de paso de diferentes tipos de válvulas.
- Máxima sujeción garantizada, gracias a los dientes de acero que sujetan la válvula en la posición correcta y al diseño de eje rotatorio, que permite ajustar el dispositivo al máximo.
- Fabricado en poliamida de alta resistencia a los golpes y al desgaste. También posee una alta capacidad aislante a temperaturas entre -40°C y 180° C.
- Las partes metálicas están fabricadas en acero inoxidable.
- Se adaptan a anchuras de manilla de hasta 45 mm. con un espesor máximo de 25 mm.
- Bloqueo con hasta 2 candados con diámetro de arco máximo de 8,5 mm.
- Designed to secure the stopcock on various types of valve.
- Maximum security guaranteed thanks to steel teeth that secure the valve in the correct position and the rotating axis design that enables the device to be fully adjusted.
- Made from high performance polyamide, an extremely impact and wear resistant material. It also has high insulation strength against extreme temperatures.
- The metallic parts (arms, teeth and screws) are made from stainless steel.
- Resistant to temperatures between -40°C and 180°C.
- They adapt to handle widths up to 45mm and a maximum thickness of 25mm.
- Lockable with up to two padlocks with shackle diameter up to 8.5mm.

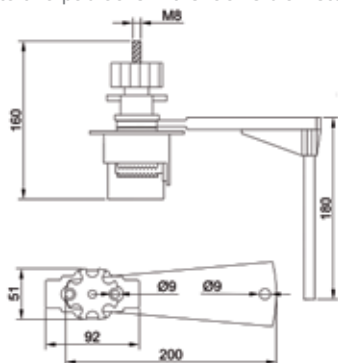

Ref.	Cod.	Pack	Uni.
Bloqueo para válvulas de brazo doble Valve lockout with double blocking arm	090400		2

## Bloq. elementos neumáticos

Lockout for pneumatical elements

N

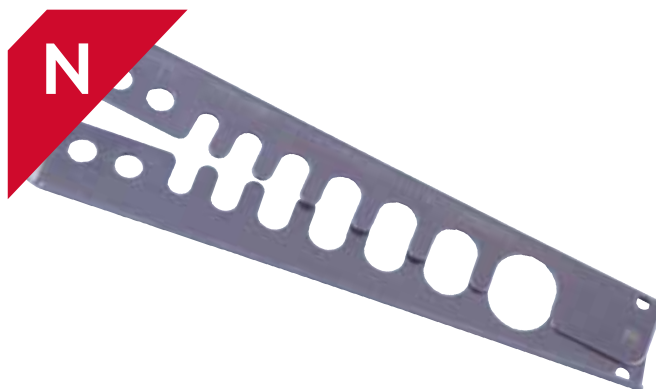

- Bloqueo para elementos neumáticos y boquillas de gas/aire de diferentes diámetros.
- Fabricado en acero inoxidable para evitar problemas de corrosión y poder utilizarse a la intemperie.
- Cuenta con 7 orificios con diámetros de entre 7 y 20 mm., lo que le convierte en compatible con la mayoría de elementos neumáticos utilizados en cualquier fábrica o instalación industrial.
- Se puede bloquear hasta con dos candados de diámetro de arco máximo 8 mm.
- Locking device for pneumatic elements and gas / air nozzles of different diameters.
- Made of stainless steel to avoid corrosion and to be able to be used outdoors.
- Its 7 holes, with diameters between 7 and 20mm, make this device compatible with most pneumatic elements used in any factory or industrial facility.
- It can be locked up with two padlocks with shackle diameter up to 8mm.

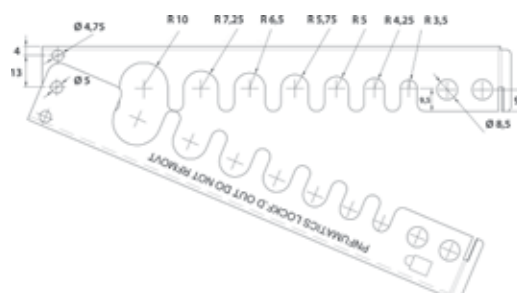

Ref.	Cod.	Pack	Uni.	€/uni.
Bloqueo para elementos neumáticos B Lockout for pneumatical elements B	090460		10	13,33

## Bloqueo gas/aire

Gas / air lockout

N



- Sistema para válvulas sin accesorios de manejo (volantes, palancas, llaves de paso, etc.) que no son sencillas de inmovilizar con otros elementos de bloqueo.
- Válida para válvulas cuya conexión para accesorios de manejo sea de 25 ó 35 mm.
- Fabricado en resinas de alta resistencia preparadas para soportar temperaturas extremas, corrosión, agentes químicos y rayos ultravioleta.
- Tamaño compacto y facilidad de uso.
- El dispositivo se bloquea con un único candado de arco de diámetro máximo de 9 mm.
- Lockout system for valves with no operating accessories (wheels, levers, valve keys, etc.) that are not easy to block using other lockout devices.
- Suitable for valves in which the connection for operating accessories is between 25 to 35mm.
- Made from high-resistance resins ready to withstand extreme temperatures, corrosion, chemical agents and UV rays.
- Compact and easy-to-use.
- Lockable with a single padlock with shackle diameter up to 9mm.

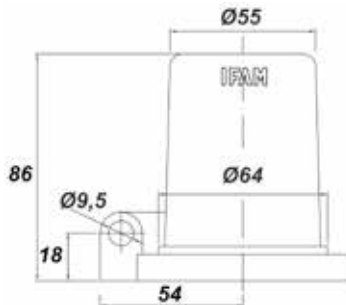

Ref.	Cod.	Pack	Uni.
Bloqueo válvulas de gas/aire 25 / 35mm 25/35mm gas/air valve lockout	090485		6

## Caja vertical 14 candados

Vertical lockout box 14 padlocks



- Las cajas de bloqueo son ideales para los grupos encargados de tareas de mantenimiento que trabajen por turnos, con horarios escalonados o mediante subcontrata.
- La caja de bloqueo sirve para guardar hasta 12 candados de consignación, llaves, etiquetas y demás elementos del equipo necesarios durante las operaciones de reparación, mantenimiento o supervisión de la maquinaria.
- La caja se cierra con hasta 14 los candados de consignación de los miembros del grupo. Así se impide que trabajadores no autorizados a realizar tareas de mantenimiento de maquinaria y equipos pueden acceder a este material de consignación.
- Lock boxes are ideal for the groups responsible for maintenance working in shifts, with staggered hours or by subcontracting.
- The lock box can store up to 14 lockout-tagout padlocks, keys, labels and other items of equipment required for repair operations, maintenance or equipment monitoring.
- The box closes with the group's lockout-tagout padlocks. This prevents unauthorized workers to perform maintenance of machinery and equipment from accessing this material.

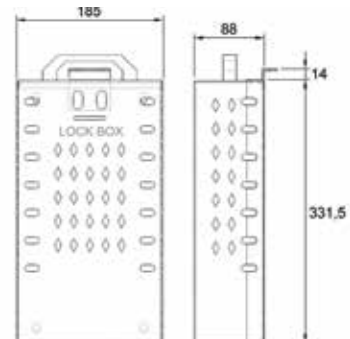

Ref.	Cod.	Pack	Uni.
Caja bloqueo vertical 14 candados Vertical lockout box for 14 padlocks	090545		1



# IFAM



## ANTIRROBOS DE MOTO MOTORCYCLE LOCKS

**ANTIRROBOS DE  
CADENA Y ANCLAJES**  
CHAIN LOCKS  
AND ANCHORS



PAG. 82

**ANTIRROBOS DE  
RÓTULAS**  
BALL-JOINT  
LOCKS



PAG. 86

**ANTIRROBOS DE  
DISCO**  
BRAKE DISC  
LOCKS



PAG. 87

**OTROS ANTIRROBOS  
DE MOTO**  
OTHER MOTORCYCLE  
LOCKS



PAG. 92



## H14



- Cadena de acero aleado al manganeso de alta resistencia.
  - Resistencia a la tracción superior a 15 tm.
  - Eslabones con sección hexagonal con 14 mm.
  - Baño de níquel de alta durabilidad frente a la oxidación.
  - Excelente flexibilidad.
  - Forrada con tela resistente de nylon negro.
  - Último eslabón más largo para facilitar el perfecto acoplamiento de los candados IFAM de alta seguridad.
  - Dos medidas: 1,20m y 1,60m.
- High resistance manganese alloy steel chain.
  - Tensile strength in excess of more than 15 tonnes.
  - Links with a 14 mm hexagonal cross section.
  - Nickel plating that is highly durable against rust.
  - Excellent flexibility.
  - Covered with a black nylon resistant cloth.
  - Elongated end link for easier fitting of IFAM high security padlocks.
  - Available in two different lengths: 1.2m and 1.6m.

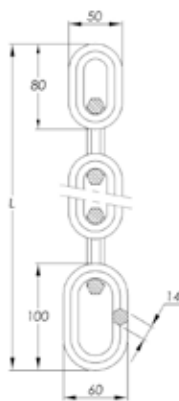

Ref.	Cod.		IPL	Pack	Uni.
H14x120	000885	1,2 m	10		1
H14x160	000886	1,6 m	10		1

## Checkered flag



- Eslabones de 10mm de grosor.
  - Eslabones de acero templado para una gran resistencia al corte.
  - Último eslabón con mayor diámetro para proporcionar un máximo ajuste cuando la cadena se cierra con un candado.
  - Forrada con tela de nylon de gran resistencia para evitar el roce con la moto. Forrada con tela de nylon de gran resistencia para proteger de roces la cadena y la propia moto.
  - Disponible en dos longitudes: 1,20m y 1,60m.
- Link thickness: 10 mm.
  - Tempered steel links for high cut resistance.
  - Its final link has a larger diameter to enable maximum adjustment when closing the chain with a padlock.
  - Covered with high-resistance nylon to prevent contact between the chain and the motorcycle.
  - Available in two lengths: 1.2m and 1.6m.

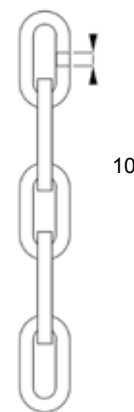

Ref.	Cod.		IPL	Pack	Uni.
Checkered flag 120	000878	1,2 m	7		1
Checkered flag 160	000879	1,6 m	7		1

## Black Flag



- Eslabones de acero zincado para prevenir la corrosión
- Forrada con tela de nylon de gran resistencia para evitar el roce de los eslabones con la moto.
- Diámetro del eslabón: 8mm
- Disponible en 3 tamaños: 1.20m, 1.60m y 2m
- Excelente flexibilidad.

- Zinc-plated steel links to prevent corrosion
- Covered with high-resistance nylon fabric to prevent contact between the chain and the motorcycle.
- Link diameter: 8 mm.
- Available in three lengths: 1.2 m, 1.6 m and 2 m.
- Excellent flexibility.



Ref.	Cod.		IPL	Pack	Uni.
Black Flag 120	000850	1,2 m			1
Black Flag 160	000852	1,6 m			1
Black Flag 200	000854	2 m			1

## C10



- Eslabones de sección cuadrada en acero zincado para prevenir la oxidación.
- Longitud: 120 cm.
- Grosor de los eslabones: 10mm.
- Incluye dos llaves de regata.
- Sistema de retención de llave en la cerradura con el antirrobo abierto.
- Protección de la cerradura con pestañas de plástico para evitar la entrada de polvo y humedad.
- Funda de nylon para proteger la moto de roces con los eslabones.

- Square zinc-plated steel links to prevent corrosion.
- Length: 120cm.
- Link diameter: 10mm.
- Supplied with 2 laser keys.
- Key retention system when the lock is open.
- Plastic cover to protect the lock from dust and humidity.

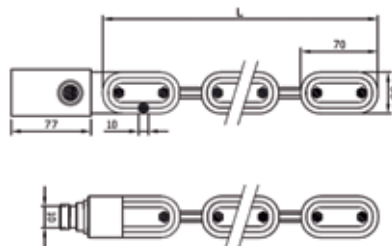

Ref.	Cod.		IPL	Pack	Uni.
C10	000893	1,2 m	8		1



## M10



- Cadena de acero aleado de alta resistencia.
- Resistencia a la tracción superior a 8 toneladas.
- Forrada con tela protectora de nylon negro.
- Excelente flexibilidad.
- Último eslabón más largo para facilitar el perfecto acoplamiento de los candados IFAM de alta seguridad.
- Eslabones con sección cuadrada de 10 mm.

- High resistance alloy steel chain.
- Tensile strength in excess of more than 8 tons.
- Covered with a black nylon protective cloth.
- Excellent flexibility.
- Elongated end link for easier fitting of IFAM high security padlocks.
- Links with a 10 mm square cross section.

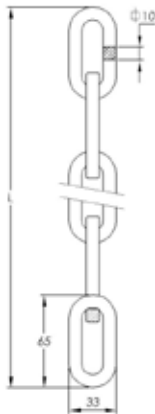

Ref.	Cod.		IPL	Pack	Uni.
M10x120	000881	1,2 m	8		1
M10x160	000882	1,6 m	8		1
M10x200	000883	2 m	8		1

## AS1



- El complemento perfecto para los antirrobos de cadena IFAM a la hora de proteger su moto.
- Anilla de aleación de acero de 14 mm. de diámetro.
- Nivel de dureza de la anilla 55-58 HRC, que le hace especialmente resistente a los ataques.
- Base de acero de 6 mm. de espesor, con resistencia extra anti-taladro.
- Incluye tornillos de anclaje de diámetro 16 para su fijación permanente en superficie de hormigón.

- The perfect complement to IFAM's anti-theft chains when it comes to protecting your motorbike.
- Steel alloy shackle 14 mm. in diameter.
- 55-58 HRC shackle hardness level, which makes it particularly resistant to attacks.
- Steel base of 6 mm. thick with anti-drill extra strength.
- Includes anchor bolts of 16mm diameter for permanent attachment to concrete surfaces.

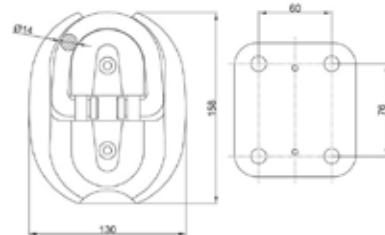

Ref.	Cod.	IPL	Pack	Uni.
AS1	000483	10		1

## Stop & Go



- Válido para asegurar vehículos de dos ruedas en garajes, sótanos, aparcamientos privados, etc.
- Apto para su montaje en el suelo o en paredes.
- Incluye todos los elementos necesarios para su instalación.
- Chapa de acero soldada de 5 mm de espesor.
- Distancia entre ejes: 86.5mm
- Disponible en 2 colores: negro y rojo.
- Recubierto por una gruesa capa de pintura para evitar su oxidación.
- Válido para su uso tanto en interior como en exterior.

- Suitable for securing two-wheeled vehicles in garages, basements, private car parks, etc.
- Can be mounted on the floor or a wall.
- Includes all the necessary parts for installation.
- 5 mm welded steel plate.
- Distance between axes: 86.5 mm
- Available in two colours: black or red.
- Coated in a thick layer of paint to avoid rust. Suitable for both indoor and outdoor use.

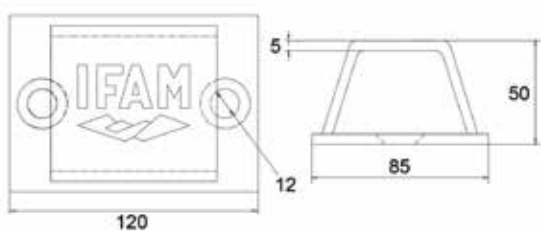

Ref.	Cl.	Cod.	IPL	Pack	Uni.
Stop and Go	■	000481R	7	🔒	1
Stop and Go	■	000481N	7	🔒	1



## Basic



- Antirrobo por sistema de rótulas con revestimiento de plástico para evitar rozaduras.
- Gran flexibilidad de las rótulas, que hace que se pueda enrollar fácilmente para su transporte en la moto.
- Se suministra con dos llaves tubulares.
- Dos longitudes: 1 m. (Basic 100) y 1,20 m. (Basic 120).

- Ball-joint lock with plastic coating to prevent chafing.
- Great flexibility to make it easier to roll up and carry on the motorcycle.
- Supplied with two tubular keys.
- Two lengths: 1 m. (Basic 100) and 1.20 m. (Basic 120).

Ref.	Cod.	Length	IPL	Pack	Uni.
Traveller 100	053011	1 m	10		1

## Wheelie



- Antirrobo de rótulas con alarma de 110dB incorporada a la cerradura.
- Rótulas de 2.5 mm de espesor. Las rótulas se solapan para mayor protección del cable interior de acero trenzado, de 5mm de espesor.
- Cubierta de resistente PVC para evitar el roce de las rótulas con la moto.
- Cerradura de puntos de seguridad fabricada en acero y con sistema anti-ganzúa.
- Se suministra con 3 llaves de discos.
- Disponible en 3 tamaños: 1m, 1.20m y 1.50m
- Incluye 2 pilas de botón de 3V CR2032.

- Cable lock with a 110 dB alarm built-in.
- 2.5 mm thick joints. The joints overlap for increased protection of the interior 5 mm steel wire cable.
- High-resistance PVC casing to avoid scratches with the motorcycle.
- Steel dimple lock with an anti-pick system. • Supplied with three disc keys.
- Available in three lengths: 1 m, 1.2 m and 1.5 m.
- Includes two 3V CR2032 button batteries.



Ref.	Cod.	Length	IPL	Pack	Uni.
Wheelie 100	046500	1 m	9		1
Wheelie 120	046510	1,2 m	9		1
Wheelie 150	046520	1,5 m	9		1

## Slide



- Rótulas de 3mm de espesor. Las rótulas se solapan para mayor protección del cable interior de acero trenzado, de 5mm de espesor.
- Cubierta de resistente PVC para evitar el roce de las rótulas con la moto.
- Cerradura de acero anti-ganzúa con llave de regata.
- Se suministra con 3 llaves.
- Disponible en 1m, 1.20m y 1.50m
- Excelente flexibilidad

- 3 mm thick joints. The joints overlap for increased protection of the interior 5 mm steel wire cable.
- High-resistance PVC casing to avoid contact between the joints and the motorcycle.
- Anti-pick steel lock with laser key.
- Supplied with three keys.
- Available in 1 m, 1.2 m and 1.5 m.
- Excellent flexibility.

Ref.	Cod.	Length	IPL	Pack	Uni.
Slide 100	046400	1 m	7		1
Slide 120	046410	1,2 m	7		1
Slide 150	046420	1,5 m	7		1

# Antirrobo de disco - Brake disc locks

## Disc Giant 80



- Cuerpo robusto de acero carbonitrurado y con una capa de pintura especial para su protección.
- Pasador de acero templado y cromado de 15 mm. de diámetro.
- Sistema de cierre de doble bloqueo de alta seguridad.
- Bombillo de puntos de seguridad blindado por dos escudos de acero endurecido.
- 3 llaves reversibles de puntos con millones de combinaciones.
- Especialmente diseñado para un perfecto bloqueo de la rueda delantera.
- Incluye funda resistente de tela, cable recordatorio y soporte.
- Llave compatible con: candados Hércules A,B y Titán; cadena Top Giant y antirrobo Traveller Mini Secure.

- Solid carbon-nitrate steel body with a special protective paint.
- Hardened and chrome plated steel pins measuring 15 mm in diameter.
- High security double locking system.
- Dimple key tumbler cylinder armoured with two hardened steel escutcheons.
- 3 reversible dimple keys with millions of differs.
- Specially designed for a perfect locking of the front wheel.
- Includes a resistant cloth bag, spiral type cable and bracket.
- Key compatible with: Hercules A, B, and Titan padlocks; Top Giant chain and Traveller Mini Secure brake disc lock.

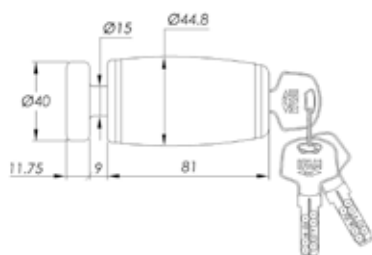
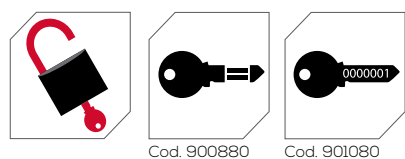

Ref.	Cod.	IPL	Pack	Uni.
Disk Giant 80	053093	10		1

## Rookie



- Cuerpo con doble anclaje de refuerzo en V.
- Cuerpo de aleación de zinc.
- Cerradura automática de llave de puntos con miles de combinaciones y pasador anti-taladro.
- Pasador de acero endurecido. Diámetro: 5,5 mm.
- Disponible en 3 colores: negro, amarillo y rojo.
- Recubierto por una gruesa capa de pintura para evitar su oxidación.
- Válido para su uso tanto en interior como en exterior.
- Se suministra con tres 3 llaves de puntos de seguridad.
- Llave compatible con antirrobo Wild Card y Custom Steel 50.

- V-shaped double-anchor body.
- Body made from zinc alloy.
- Automatic dimple key lock with thousands of combinations and a drill-resistant shackle pin.
- Supplied with three dimple keys.
- Hardened steel shackle pin. Diameter: 5.5 mm.
- Available in 3 colours: black, yellow and red.
- Coated in a thick layer of paint to avoid rust.
- Suitable for both indoor and outdoor use.
- Key compatible with Wild Card and Custom Steel 50 models.

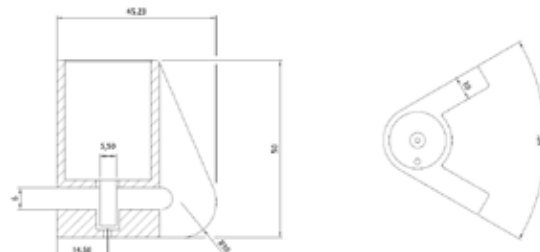
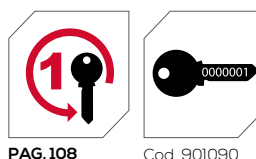

Ref.	Cl.	Cod.	Pack	Uni.
Rookie		053010A		12
Rookie		053010N		12
Rookie		053010R		12



## Wild Card



- Antirrobo de bolsillo con un gran nivel de seguridad.
- Cuerpo de acero carbonitrurado y templado. Máxima resistencia al corte.
- Cerradura de puntos con miles de combinaciones y pasador antitaladro.
- Pasador de acero endurecido. Diámetro 5,5 mm.
- Se suministra con 3 llaves de puntos de seguridad.
- Disponible en 3 colores: cromo, rojo y negro
- Pintura de alta resistencia a los roces con la moto.
- Llave compatible con antirrobo Rookie y Custom Steel 50.

- High-security pocket-sized lock.
- Body made from carbonitrided and tempered steel. Maximum cut resistance.
- Dimple lock with thousands of combinations and a drill-resistant bolt.
- Hardened steel bolt. Diameter 5.5 (WildCard X) and 10 mm (WildCard Y).
- Supplied with three dimple keys.
- Available in three colours: chrome, red or black.
- The paint is highly resistant to contact with the motorcycle.
- Key compatible with Rookie and Custom Steel 50 locks.

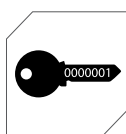

Cod. 901100



PAG.108

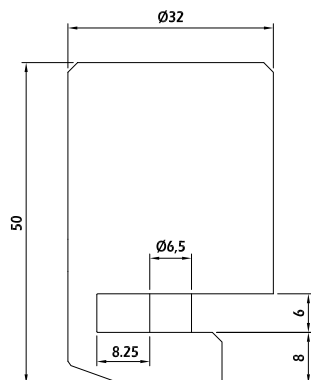

Ref.	Cl.	Cod.	IPL	Pack	Uni.
Wild card	■	053061R	7	📦	1
Wild card	■	053061C	7	📦	1
Wild card	■	053061A	7	📦	1

## Storm Lock



- Sistema de alarma (110 dbA). Sensor de movimiento que alerta de la manipulación del antirrobo.
- Pasador de acero de 7 mm. de diámetro.
- Cuerpo de aleación de zinc niquelado y cromado.
- Funda resistente de tela y juego de pilas de repuesto.
- Se suministra con llave de apertura para facilitar el cambio de pilas.
- Suministrado con 2 llaves planas de seguridad.

- Alarm system (110 dbA). Movement sensor alerting about possible thefts.
- Steel shackle pin measuring 7 mm in diameter.
- Body made of a nickel zinc and chrome plated alloy.
- Supplied with 2 flat security keys.
- Resistant cloth bag and set of spare batteries.

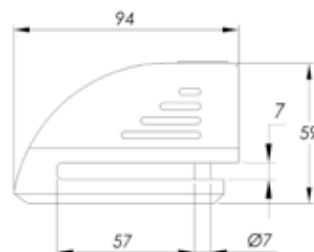

Ref.	Cl.	Cod.	IPL	Pack	Uni.
Storm Lock	■	053106	8	📦	1
Storm Lock	■	053106R	8	📦	1
Storm Lock	■	053106A	8	📦	1
Storm Lock	■	053106N	8	📦	1



## Power

N



- Cuerpo robusto de aleación de zinc niquelado y pintado/cromado.
- Arco de acero templado y endurecido. Diámetro: 13 mm.
- Protector de cuerpo fabricado en plástico resistente para protegerlo de los roces con la moto.
- Guardapolvo para evitar la entrada de suciedad y humedad en la cerradura.
- Suministrado con 3 llaves de discos, funda de tela y cable recordatorio.
- Disponible en 3 colores: rojo, amarillo y cromo.

- Solid painted/chromed nickel-plated zinc alloy body.
- Tempered and hardened steel shackle. Diameter: 13 mm.
- Body protector made from tough plastic to protect against contact with the motorcycle.
- Dust cover to prevent the entry of dirt or damp into the lock.
- Supplied with three disc keys, fabric cover and reminder cable.
- Available in three colours: red, yellow and chrome.

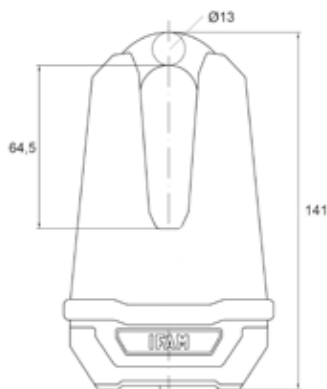

Ref.	Cl.	Cod.	IPL	Pack	Uni.
Power	■	054040R	8		1
Power	■	054040C	8		1
Power	■	054040A	8		1

## Master Disk



- Cuerpo de aleación de zinc.
- Arco de 13 mm. de diámetro.
- Cerradura de discos con miles de combinaciones.
- Protector de cuerpo resistente.
- Incluye funda de tela y cable recordatorio.
- Suministrado con 3 llaves de discos, una de ellas con LED luminoso para visión nocturna.

- Body made of zinc alloy.
- Shackle measuring 13 mm in diameter.
- Disc type lock with thousands of differs.
- Resistant body protector.
- Includes a cloth bag and spiral type cable.
- Supplied with 3 disc type keys; one of them with an LED for night vision.

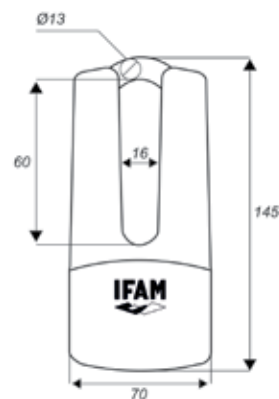

Ref.	Cod.	IPL	Pack	Uni.
Master Disk	053043C	8		1



## Custom Steel 50



- Antirrobo de acero carbonitrurado y templado.
  - Cerradura automática de llave tubular con sistema de seguridad antitaladro.
  - Pasador de acero endurecido de 5,5 mm.
  - Cuerpo cromado de alta resistencia a la oxidación.
  - Incluye cable recordatorio para colocarlo en el disco de freno.
  - 2 llaves tubulares.
  - Llave compatible con antirrobo Wild Card y Rookie.
- Carbon-nitrate tempered steel anti-theft device.
  - Tubular key automatic locking with anti-drilling security system.
  - 5.5 mm hardened steel shackle pin.
  - High rust resistant chrome plated body.
  - Includes a reminder spiral type cable.
  - 2 tubular keys.
  - Key compatible with Wild Card and Rookie locks.

## Road



- Cierre automático con llave de discos.
  - Protector antipolvo.
  - Pasador de cierre endurecido.
  - Dos longitudes: 75 mm. (Road 75) y 100 mm. (Road100).
  - Tres colores: amarillo, cromado y rojo.
  - Atractivo diseño.
  - 3 llaves tubulares (1 de ellas con led).
- Automatic lock with disc type key.
  - Dust-proof protector.
  - Hardened steel shackle pin.
  - Two lengths: 75mm (Road 75) and 100mm (Road100).
  - Three colours: yellow, chrome plated and red.
  - Attractive design.
  - 3 tubular keys (1 of them with LED).

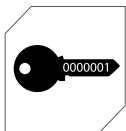

Cod. 901110



PAG.108

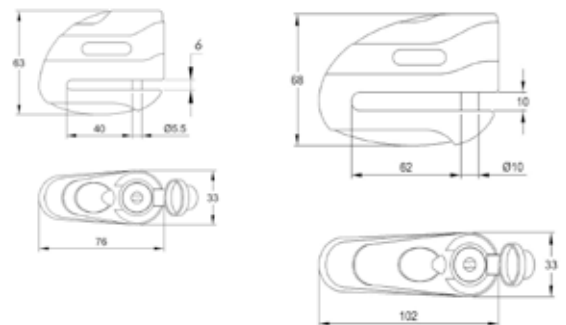
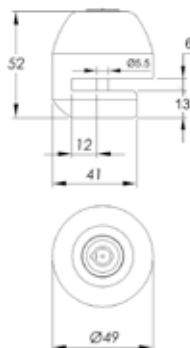

Ref.	Cod.	IPL	Pack	Uni.
Custom Steel 50	053063	9		1

Ref.	Cl.	Cod.	IPL	Pack	Uni.
Road75		053081A	75mm	7	6
Road75		053081R	75mm	7	6
Road75		053081C	75mm	7	6
Road100		053083A	100mm	7	6
Road100		053083R	100mm	7	6
Road100		053083C	100mm	7	6

## DF11



- Cierre automático con llave tubular.
- Protector antipolvo.
- Pasador de cierre endurecido.
- Tres colores: amarillo, cromado y rojo.
- Atractivo diseño.
- Se suministra con dos llaves tubulares.
- Incluye funda resistente de tela.

- Automatic locking with tubular key.
- Dust-proof protector.
- Hardened steel shackle pin.
- Three colours: Yellow, chrome plated and red.
- Attractive design.
- Supplied with two tubular keys.
- Includes a resistant cloth bag.

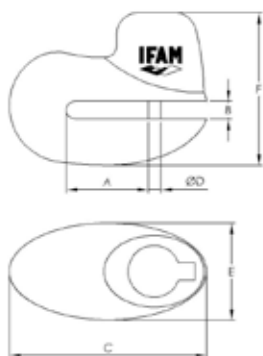

Ref.	Cl.	Cod.	IPL	Pack	Uni.
DF11	■	053086A	7	🔑	6
DF11	■	053086R	7	🔑	6
DF11	■	053086C	7	🔑	6

## DF1 /DF2 /DF3



- Válido para todas las motos con disco ventilado.
- Cuerpo monoblock de aleación por sistema de inyección.
- Cerradura automática en acero con miles de combinaciones.
- Dos colores: amarillo y rojo.
- 2 llaves tubulares.

- Valid for all motorcycles with ventilated discs.
- Injected alloy monoblock body.
- Automatic steel lock with thousands of differs.
- Two colours: yellow and red.
- 2 tubular keys.

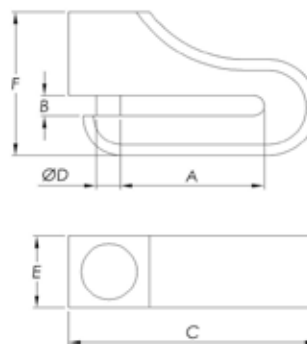

Ref.	Cl.	Cod.	IPL	A	B	C	D	E	F	Pack	Uni.
DF1	■	053076A	6	21	6	48	5,5	275	47	🔑	10
DF1	■	053076R	6	21	6	48	5,5	275	47	🔑	10
DF2	■	053077A	6	37	6	66	5,5	28	51	🔑	10
DF2	■	053077R	6	37	6	66	5,5	28	51	🔑	10
DF3	■	053078A	6	60	8,5	103	10	30	50	🔑	10
DF3	■	053078R	6	37	6	66	5,5	28	51	🔑	10



## Rec110



- Cable espiral de seguridad cuya función es recordar al usuario que debe retirar el antirrobo antes de arrancar su moto.
- Longitud: 1,10 m.
- Se coloca un extremo del cable en el antirrobo y otro en el manillar. Así, el usuario evita caídas o roturas en la moto si arrancara con el antirrobo puesto.
- Spiral cable to remind the user that the brake disc lock has to be removed before starting the motorcycle.
- Length: 1.10 m.
- One end of the cable is placed on the anti-theft device and the other one on the handle bar. This way the user prevents falls or damaging the motorcycle if it were to be started with the lock installed.

Ref.	Cod.	Pack	Uni.
Rec110	000505		15

## Pole



- Horquilla patentada y certificada de máxima seguridad, de acuerdo a la norma SRA.
- Arco de acero al molibdeno endurecido y carbonitrurado. Diámetro: 22,4 mm.
- Cuerpo blindado con tubo de acero macizo anticorte, anti-cizalla.
- Doble anclaje anti-extracción homologado.
- Cerradura de llave de discos con tapa protectora del polvo y la suciedad.
- Incluye 3 llaves de discos.
- Incluye soporte para facilitar su transporte.
- Patented and certified U-shackle lock in accordance to the SRA standard.
- Hardened and carbonitrided molybdenum steel.
- Reinforced body with a solid, anti-cut or anti-saw steel.
- Double anchored official anti-extraction.
- Hardened steel pin: 5.5mm in diameter (Pole 100) and 10mm in diameter (Pole 315).
- Disc key locks with dust and dirt protective cover.
- Includes 3 keys.
- Includes support to facilitate transport.

## SDF12



- Su sencillo mecanismo de fijación a la moto y de acoplamiento al antirrobo evita la aparición de ruidos molestos.
- Fácil instalación y adaptación a cualquier tipo de moto.
- Fabricado en acero cincado antioxidación.
- Place this bracket on the motorcycle and prevent the appearance of disturbing noise while carrying the lock..
- It can be easily installed and adapted to any type of motorcycle.
- Manufactured in rust-resistant zinc plated steel.

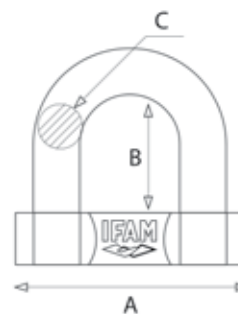

Ref.	Cod.	A	B	C	IPL	Pack	Uni.
Pole 100	000592	157	85	224	10		6
Pole 315	000594	157	300	224	10		6

Ref.	Cod.	Pack	Uni.
Soporte SDF12	053070		1



## ANTIRROBOS DE BICICLETA BICYCLE LOCKS

ANTIRROBOS DE  
BICICLETA  
BICYCLE LOCKS



PAG. 94



## Barcelona 160



- Antirrobo multifuncional que incluye linterna frontal, luces traseras y horquilla.
- Horquilla de acero endurecido de diámetro 10 mm con tratamiento anticorrosión, recubierto con carcasa de PVC para protegerlo de rozaduras y golpes
- Se suministra con 2 llaves de regata. Sistema de retención de llave.
- Linterna frontal con una potente luz LED
- Linterna trasera con 3 potentes luces LED y 3 modos de iluminación.
- Se suministra con 2 soportes, uno para la linterna frontal y otro para las luces traseras y la horquilla.
- Incluye 5 baterías para las linternas, pilas AAA.

- Multi-functional lock that includes front light, rear light and D-lock.
- 10 mm hardened steel U-shackle lock with anti-corrosion treatment. Covered in a PVC casing to protect the lock and the bicycle from scratches.
- Supplied with two laser key. Key retention system.
- Front light with powerful LED light source.
- Rear light with three powerful LED light sources and three modes.
- Supplied with two brackets, one for the front light and another for the rear light and the U-shackle lock.
- Includes five AAA batteries for the lights.

Ref.	Cod.	IPL	Pack	Uni.
Barcelona 160	000597	6		1

## Copenhagen



- Antirrobo retráctil de fácil transporte.
- Placas de acero con tratamiento anti-oxidación de 3.5 mm de espesor y 20mm de ancho que aportan gran eficacia anti-corte.
- Placas recubiertas de película plástica para evitar roces con la pintura de la moto.
- Cerradura de seguridad con llaves de regata.
- Se suministra con 2 llaves.
- Disponible en dos longitudes: 80 cm y 90 cm.
- Incluye soporte para su transporte

- Retractable lock for easy transportation.
- 3.5 mm thick and 20 mm wide steel plates with anti-rust treatment to offer high anti-cut effectiveness. Plates coated in plastic film to avoid contact with the motorcycle paint.
- Security lock with laser keys.
- Supplied with two keys.
- Available in two lengths: 80cm and 90cm.
- Includes transport bracket.

Ref.	Cod.	IPL	Pack	Uni.
Copenhagen 80	046600	6		1
Copenhagen 90	046610	6		1

## Rotterdam



- Cuerpo de acero recubierto con carcasa de PVC para proteger el antirrobo de rozaduras y golpes
- Cerradura en el lateral para una mayor manejabilidad.
- Arco de acero endurecido de diámetro 12 mm con tratamiento anticorrosión. Su recubrimiento plástico lo protege de rozaduras con la bicicleta.
- Cerradura de llave de discos. Incluye 3 llaves.
- Disponible en 3 tamaños: 210, 245 y 320 mm.
- Incluye soporte para su transporte

- Steel body covered in a PVC casing to protect the lock and the bicycle from scratches.
- Lock on the side for easier handling.
- Hardened steel 12mm shackle with rust-proof treatment. Plastic cover to protect the bicycle from scratches.
- Supplied with 3 disc type keys.
- Available in 3 sizes: 210, 245 and 320 mm.
- Includes a carrying bag.

Ref.	Cod.	IPL	Pack	Uni.
Rotterdam 210	000585	7		1
Rotterdam 245	000586	7		1
Rotterdam 320	000587	7		1

## Spiral Combinacion 180



- Cable de acero galvanizado revestido de vinilo.
- Sistema de apertura por rodillos con 10.000 combinaciones posibles.
- Autoprogramable.
- Longitud: 180 cm. Diámetro 8 mm.
- Incluye soporte para la bicicleta.

- Vinyl coated galvanised steel cable.
- Rotating wheel type opening system with 10.000 differs.
- The combination can be changed.
- Length: 180 cm. 8 mm in diameter.
- Includes a bracket for the bicycle.

Ref.	Cod.		IPL	Pack	Uni.
Spiral Combinacion 180	053045C	180cm	8		12



## Spiral Junior



- Cable de acero galvanizado recubierto de vinilo.
- Terminal cromado revestido de caucho.
- Longitud: 180 cm. Diámetro 8 mm.
- Se suministra con dos llaves de regata.
- Cuatro colores a elegir: negro, rojo, azul y verde.
- Incluye soporte para su fijación a la bicicleta.

- Vinyl coated galvanised steel cable.
- Chrome plated terminal and rubber sheathed.
- Length: 180 cm. 8 mm in diameter.
- Supplied with two standard keys.
- 4 colours to choose: black, red, blue and green.
- Bracket included.

Ref.	Color	Cod.	Length	IPL	Pack	Uni.
Spiral Junior	Blue	000502B	180cm	6		10
Spiral Junior	Black	000502N	180cm	6		10
Spiral Junior	Red	000502R	180cm	6		10
Spiral Junior	Green	000502V	180cm	6		10

## Spiral Plus



- Cable de acero galvanizado recubierto de vinilo.
- Longitud del cable: 180 cm.
- Diámetro del cable: 12 mm.
- Se suministra con dos llaves de discos.
- Sistema de retención de llave con el antirrobo abierto.
- Cierre con protector de plástico para evitar la entrada de polvo y suciedad.
- Incluye soporte para su fijación a la bicicleta.

- Vinyl coated galvanised steel cable.
- Cable length: 180 cm.
- Cable diameter: 12 mm.
- Supplied with 2 disc type keys.
- Key retention system when the lock is open.
- Plastic protection for preventing dust and dirt from entering the lock.
- Bracket included.

Ref.	Cod.	Length	IPL	Pack	Uni.
Spiral Plus	000504	180cm	6		6



## Trans 200



- Cable de acero plastificado de 10 mm. de diámetro.
- Longitud de 2 m., ajustable con lazo para asegurar elementos a la distancia deseada.
- Trans200K: apertura con llave. Se suministra con 2 llaves de serreta.
- Trans200C: apertura con combinación de 4 rodillos. 10.000 combinaciones posibles.
- Multiusos: asegurar bicicletas, mobiliario urbano no estático, sillas y mesas en terrazas de hostelería...

- Galvanised steel cable. 10mm in diameter.
- Length of 2 m. with adjustable loop to tie up several items at the required distance.
- Trans200K:key operated. Supplied with two keys.
- Trans200C: 4 roller combination opening with thousands of differs.
- Multipurpose: to protect bicycles, non static urban furniture, bars' outdoor tables and chairs...

Ref.	Cod.		IPL	Pack	Uni.
Trans200C	000530	200cm	7		10
Trans200K	000528	200cm	7		10

## Street



- Cable de acero con cobertura plástica. Diámetro 10 mm.
- Cerradura automática con tapa para evitar la entrada de agua, polvo y suciedad.
- 2 longitudes: 65 cm. (Street65) y 90 cm. (Street 90).
- Ideal para bicicletas pequeñas.
- Disponibles en colores verde, violeta y negro.
- Se suministra con dos llaves.

- Steel cable with plastic coating. 10 mm in diameter.
- Automatic lock covered by a lid that protects the lock from water, dust and dirt.
- Length: 65cm (Street65) and 90 cm (Street 90).
- Ideal for small bicycles.
- Available in several colours: green, purple and black.
- Supplied with two keys.

Ref.	Color	Cod.		IPL	Pack	Uni.
Street 65		000362	65cm	6		20
Street 65		000363	65cm	6		20
Street 65		000364	65cm	6		20
Street 90		000392	90cm	6		20



## XL200



- Cable de acero galvanizado revestido de vinilo.
- Se puede combinar con cualquiera de los candados IFAM.
- Longitud: 2 m. Diámetro 10 mm.
- Multiusos: asegurar bicicletas, mobiliario urbano no estático, sillas y mesas en terrazas de hostelería...

- Vinyl coated galvanised steel cable.
- Can be used with any IFAM lock.
- Length: 2 m and 10 mm in diameter.
- Multiple uses: Lock bicycles, non static street furniture, chairs and tables in terraces, etc.

Ref.	Cod.	Length	IPL	Pack	Uni.
XL200	000520	200cm	7		6

## Cables Junior - Junior Cables



- Cable de acero recubierto de vinilo.
- Cuerpo fundido y cromado.
- Longitud: 50cm. (Junior50) y 60cm. (Junior60 y Junior60 combi). Diámetro 5 mm.
- Disponible en colores azul, rojo y negro.
- Disponible con 2 llaves o apertura con combinación.

- Vinyl coated steel cable.
- Hardened and chrome plated body.
- Length: 50cm (Junior50) and 60cm (Junior 60 and Junior60 combi). 5 mm in diameter.
- Available in three colours: red, blue and black.
- Available with 2 keys or combination lock.

Ref.	Color	Cod.	Length	IPL	Pack	Uni.
Junior 50		000300B	50cm	4		10
Junior 50		000300R	50cm	4		10
Junior 60		000301B	60cm	4		10
Junior 60		000301R	60cm	4		10
Junior 60		000301N	60cm	4		10
Junior 60		000301V	60cm	4		10
Junior 60 combi		000302B	60cm	4		10
Junior 60 combi		000302R	60cm	4		10

## Cadenas bicicleta - bicycle chains



- Cadenas de acero galvanizado.
- Suministradas con o sin candado.
- Funda de plástico.
- Gran flexibilidad.

- Galvanised steel chains.
- Supplied with or without padlock.
- Plastic cover.
- High flexibility.

Ref.	Cod.	Length	IPL	Pack	Uni.
L5x60	000862	60cm	6		20
L5x75	000863	75cm	6		20
L6x100	000864	100cm	6		10
L7x125	000865	125cm	6		20
L5x60 + TF30	000910	60cm	6		1
L5x75 + TF30	000920	75cm	6		1
L6x100 + TF40	000930	100cm	6		1
L7x125 + TF40	000940	125cm	6		1

## Milan

N



- Cadena de acero galvanizado.
  - Grosor de los eslabones: 5,5 mm.
  - Cierre de combinación con 4 rodillos. 10.000 combinaciones a elegir.
  - Medidas: 1m, 1.2m y 1,5m.
  - Funda de tela para protegerla roces con la bicicleta.
  - Gran flexibilidad para un ajuste rápido y sencillo.
- Galvanised steel chain.
  - Link thickness: 5.5 mm.
  - Closes with a 4-digit wheel combination. 10,000 combinations to choose from.
  - Lengths: 1 m, 1.2 m and 1.5 m.
  - Fabric cover to protect against contact with the bicycle.
  - Extreme flexibility for quick and easy adjustment.

Ref.	Cod.	📏	Pack	Uni.
Milan 5x1000	000840	100 cm		20
Milan 5x1200	000842	120 cm		15
Milan 5x1500	000844	150 cm		12

## Berlin



- Cadenas de acero galvanizado.
  - Suministradas con o sin candado.
  - Funda de tela para una mayor resistencia a la humedad y a los roces.
  - Diámetro de los eslabones: 5 mm. (Berlin 5x600, Berlin 5x750), 6 mm. (Berlin 6x1000) y 7 mm (Berlin 7x1250).
  - Gran flexibilidad.
- Vinyl coated steel cable.
  - Hardened and chrome plated body.
  - Length: 50cm (Junior50) and 60cm (Junior 60 and Junior60 combi). 5 mm in diameter.
  - Available in three colours: red, blue and black.
  - Available with 2 keys or combination lock.

Ref.	Cod.	📏	Pack	Uni.
Berlin 5x600	000870	60cm		1
Berlin 5x750	000872	75cm		1
Berlin 6x1000	000874	100cm		1
Berlin 7x1250	000876	125cm		1

## Kit Berlin + WP45



Ref.	Cod.	📏	Pack	Uni.
Berlin 5x600 + WP45	000960	60cm		1
Berlin 5x750 + WP45	000962	75cm		1
Berlin 6x1000 + WP45	000964	100cm		1
Berlin 7x1250 + WP45	000966	125cm		1

### CADENAS BERLÍN

- Cadenas de acero galvanizado.
- Funda de tela para una mayor resistencia a la humedad y a los roces.

### CANDADO WP45

- Cuerpo de láminas de acero recubierto por una funda termoplástica hermética.
- Arco de acero endurecido y cromado con cubierta termoplástica.
- Especialmente indicado para exteriores y zonas a la intemperie: WP (Weather Proof).

### BERLIN CHAINS

- Galvanised steel chains.
- Lined with cloth for higher resistance to humidity and to scratches.

### WP45 PADLOCK

- Hardened steel laminated body protected by a hermetic thermoplastic casing.
- Hardened steel chromed shackled covered by a thermoplastic casing.
- Especially recommended for outdoors: WP (Weather Proof).







## COMPLEMENTOS DE SEGURIDAD SECURITY COMPLEMENTARY PRODUCTS

**MIRILLA DIGITAL**  
DIGITAL  
DOOR VIEWER



PAG.  
102

**GUARDALLAVES**  
KEY STORAGE



PAG.  
102



## Sentinel 4.0



- Gran calidad de imagen: Sensor de 2.0 megapíxeles CMOS
  - Pantalla LCD de 4,0" TFT 800x480.
  - Amplio ángulo de visión: 160 grados.
  - Visión nocturna.
  - Mirilla con timbre incorporado.
  - Función de cámara fotográfica incorporada. 1GB de memoria.
  - Bajo consumo de energía: funciona con 3 pilas AAA, con una vida de 3.000 encendidos. La pantalla se apaga automáticamente a los 15 segundos.
  - Diseño ultrafino: 1,7 cm. de grosor y 240 gr. de peso.
  - Apta para puertas de 42 a 72 mm. de grosor. Opcional tubo adaptador para puertas de 68 a 95 mm. Consultar para otras medidas.
  - Fácil instalación.
  - Acabados: níquel y latón.
- High image quality: 2.0 megapixel CMOS sensor.
  - 4.0" 800x480 LCD screen.
  - Wide viewing angle: 160 degrees.
  - Night vision.
  - Peephole with built-in doorbell.
  - Built-in camera function. 1GB memory.
  - Low energy consumption: works with 3 AAA batteries, lifespan of 3,000 activations. The screen switches off automatically after 15 seconds.
  - Ultra-slim design: 1.7 cm thick and weighing 240 g.
  - Suitable for doors of 42 to 72 mm thick. Optional: tube adapter for doors between 68 and 95mm. Contact IFAM for other dimensions.
  - Easy installation.
  - Finishes: nickel and brass.

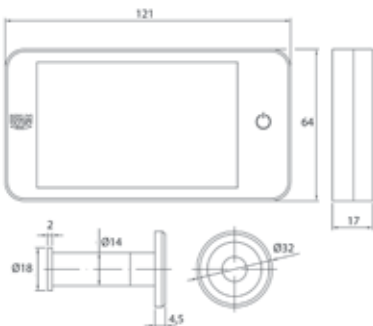

Ref.	Color	Cod.	Pack	Uni.
Sentinel 4.0		067270		1
Sentinel 4.0		067250		1
Sentinel 4.0 NC (corta /short)		067255		1
Sentinel 4.0 LC (corta/short)		067275		1
<b>ACCESORIOS - ACCESSORIES</b>				
Tubo cámara mirilla para medidas puerta 68-95 mm. Tube for door viewer camera. Door thickness 68-95mm		462990		1

## Guardallav.G1 - G1 key storage



- Ideal para viviendas unifamiliares, chalets, casas de verano...
  - Apertura de combinación de 4 rodillos. Hasta 10.000 combinaciones posibles.
  - Fabricado en aleación de aluminio de alta resistencia en exteriores.
  - Pestaña deslizante que protege los rodillos de la humedad.
  - Alta resistencia a los golpes.
  - Fácil instalación. Incluye cuatro tornillos para su fijación a la pared.
  - Espacio para guardar aproximadamente 5 llaves de casa, coche, candados...
- Ideal for apartments, villas, summer houses...
  - 4 dial combination opening. Up to 10,000 differs.
  - Made of aluminum alloy with high resistance for outdoor use.
  - Sliding shutter hatch to protect the dials from humidity.
  - High shock resistance.
  - Easy installation. Supplied with 4 screws for wall installation.
  - Capacity to store up to 5 different shape keys: house, car, padlock keys, etc...

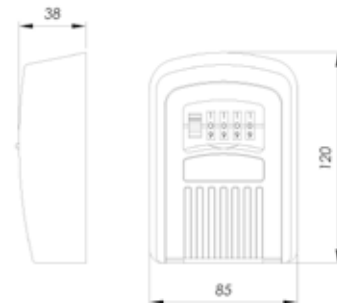

Ref.	Cod.	Pack	Uni.
G1	020174		10

## Guardallav.G2- G2 key storage



- Ideal para guardar llaves y objetos personales de pequeño tamaño mientras se realizan actividades al aire libre.
- Cuerpo de aleación de zinc con cobertura plástica de alta resistencia.
- Arco de acero con cobertura de caucho para proteger el arco de los golpes y la humedad. Diámetro de arco: 10,5 mm.
- Espacio para hasta 15 llaves de tamaño estándar aproximadamente.
- Apertura con combinación mediante 4 rodillos. 10.000 combinaciones a elegir.
- Pestaña deslizante que protege los rodillos de la humedad.

- Ideal for keeping keys and small personal belongings while outdoor activities are carried out.
- Body made of zinc alloy with high-resistance plastic casing.
- Steel shackle with rubber coating for protecting it from shocks and humidity  
Shackle diameter: 10.5 mm.
- Room for up to 15 standard sized keys approx.
- 4-dial combination lock. 10,000 differs to choose.
- Sliding lid for protecting the dials from dirt and humidity.

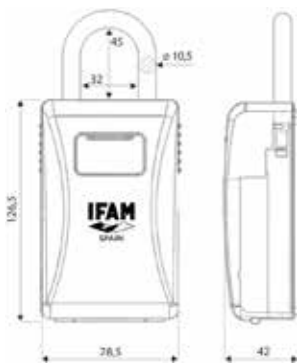

Ref.	Cod.	Pack	Uni.
G2	020185	10	10

## Guardallav.G3- G3 key storage



- Ideal para guardar llaves mientras se realizan actividades al aire libre.
- Cuerpo de aleación de zinc.
- Arco fabricado en acero. Diámetro. 6,2 mm.
- Espacio para 5 llaves de tamaño estándar aproximadamente.
- Apertura con combinación mediante 4 rodillos. 10.000 combinaciones a elegir.

- Ideal for keeping keys while outdoor activities are carried out.
- Zinc alloy body.
- Steel shackle. Diameter: 6.2 mm.
- Room for 5 standard sized keys approx.
- 4-dial combination lock.  
10,000 differs to choose.

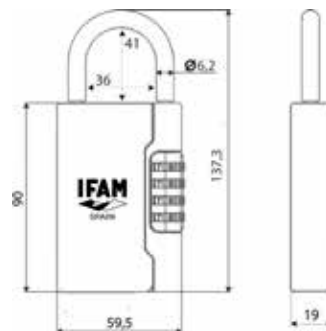

Ref.	Cod.	Pack	Uni.
G3	020189	10	10





# IFAM



## SERVICIOS SERVICES

### AMAESTRAMIENTOS IFAM

IFAM MASTER  
KEYING SERVICE



PAG.  
106

### SOLUCIÓN DE LLAVE ÚNICA

UNIQUE KEY  
SOLUTION



PAG.  
108

### PEDIDOS DE LLAVES IFAM

IFAM KEY ORDERS



PAG.  
110

EXPOSITORES  
PRODUCT STANDS



PAG.  
112



## Amaestramientos - Master keying service

### Un servicio y asesoramiento completos

En IFAM Seguridad le ofrecemos un servicio de amaestramiento a la medida de sus necesidades en el control de accesos a edificios de viviendas, oficinas, instalaciones industriales, etc.

Realizamos todo tipo de amaestramientos: desde amaestramientos simples, a amaestramientos de portal con zonas comunes, grandes amaestramientos...

### A comprehensive service and support

At IFAM Seguridad we offer a master keying service tailored to your needs for controlling access to residential buildings, offices, industrial installations, etc.

We manufacture all types of master key systems: from simple two level with a master key to much more complicated three and four level systems with grand and great grand master keys.

### ¿Qué incluye nuestro servicio de amaestramientos?

1. El estudio previo de sus necesidades para la realización del plan de amaestramiento.
2. Los cálculos.
3. La fabricación de los cilindros y llaves amaestradas.
4. El seguimiento de su plan de amaestramiento para poder realizar ampliaciones del mismo en el futuro.

### What is included in our master keying service?

1. A preliminary study of your needs, prior to carrying out a master keying plan.
2. Calculations.
3. Manufacturing of cylinders and master keys.
4. Conducting a follow up service so master keying extensions can be made in the future.

### ¿Qué documentación le entregamos?



**El Plan de Cierre** en cuadro esquemático.  
The master keying plan developed in a chart.



**Número de plan y posición** grabados en las llaves.  
Plan number and position engraved in the keys.



**Número de plan y posición** grabados en las cilindros.  
Plan number and position engraved in the cylinders.



## Amaestramiento sencillo - Simple master keying system

Un amaestramiento sencillo consiste en que varias puertas pueden ser abiertas por cada usuario con la llave correspondiente y, además, por una llave maestra que abre todas las puertas.

A simple master keying plan consists of several doors that can be opened by each user with the corresponding key and also with a master key that opens all the doors.

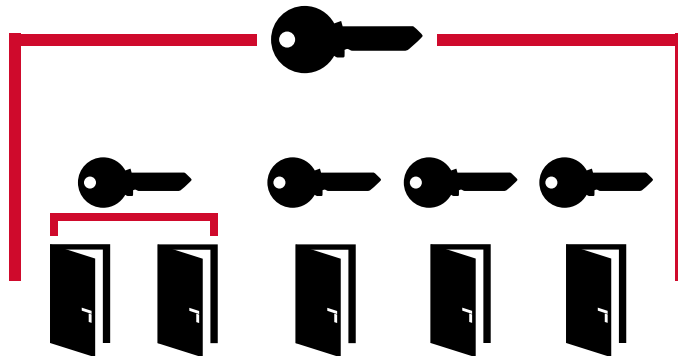

## Amaestramiento de portal - Communal entrance master keying system

Es un amaestramiento típico de comunidades de vecinos. Cada usuario tiene acceso con su llave a las puertas comunes permitidas. Se podrán integrar, en caso deseado los cilindros de la vivienda, trastero, etc.

A communal entrance master keying system for community residents. Each user can use their key to access the authorised common doors. If required, the cylinders for the homes, storerooms, etc. can be included.

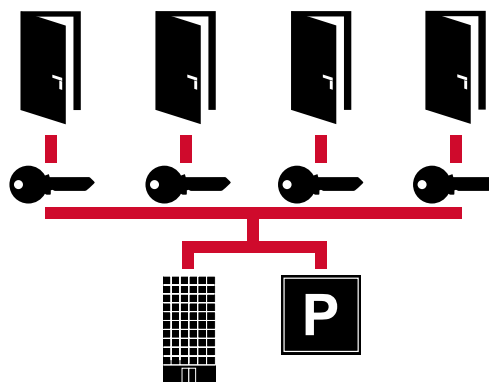

## Gran amaestramiento - Grand master keying system

En este tipo de amaestramiento, dos o más grupos de usuarios pueden tener llaves que abren su puerta y además llaves maestras que abren el resto de puertas de su grupo. En un nivel superior, existe una llave gran maestra que abre todas las puertas del edificio. Es un amaestramiento muy habitual en oficinas.

With this type of master keying system, two or more groups of users have keys that open their door as well as master keys that open the rest of the doors in their group. At a higher level, a great master key is available that opens all the doors in the building. This type of master keying plan is common at office buildings.

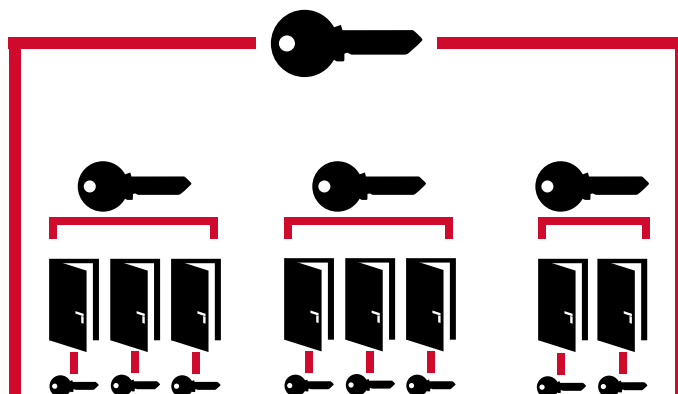

## Solución de llave única - Unique key solution

### Su bolsillo, libre de peso

Si quiere simplificar los accesos en su edificio o instalaciones y, de paso, aligerar el peso de su llavero, le ofrecemos nuestra solución de llave única.

Con una sola llave podrá abrir los cilindros, candados y cerrojos que sean compatibles entre sí, lo que simplifica y hace más cómodo su uso cotidiano.

### Feel your pocket lighter

If you want to simplify the accesses to your building or installations and at the same time lighten the weight of your key chain, you can do so using our unique key solution.

Using only one key you can open the cylinders, padlocks and locks that are compatible with each other, which simplifies and makes daily use much more convenient.

### Llave de seguridad: 6 y 16 pitones

Security key: 6 and 16 pins



Llave perfil M - M profile key



SERIE M+  
(Anti-Strap)



SERIE M



TITAN



HUNO 80



ARMOURED S



CS88 M80 / CS88 M70



CS88LV



E6

### Llave dentada: 5 pitones

Cut key: 5 pins



Llave perfil D - D profile key



SERIE D



K50



INOX 50



INOX CABLE



ARMOURED



SERIE U



MAX50



CS125



CS126



Llave perfil F5S - F5S profile key



SERIE F5S



E6



D5

## Compatibilidad entre productos IFAM- Compatibility between IFAM products

El siguiente diagrama recoge los productos IFAM SEGURIDAD cuyas llaves son compatibles entre sí. Este esquema marca las posibilidades de realización de servicios de amaestramiento, de llaves iguales o de número determinado.

The following chart shows the IFAM SEGURIDAD products that are key compatible with each other. This chart shows the possibilities of providing master key, identical key or a specific number of keys services.

- Productos con llave perfil M compatibles entre sí  
M profile key compatible products
- Productos con llave perfil D compatibles entre sí  
D profile key compatible products
- Productos con llave perfil F5S compatibles entre sí  
F5S profile key compatible products

		CILINDROS / CYLINDERS			CANDADOS / PADLOCKS							CERRADURAS Y CERROJOS / LOCKS & RIM LOCKS						
		M / M+ (Anti Snap)	D	F5S	Titán	Huno 80	K50	U 70/90	Inox 50 / Cablehox	Armoured	Armoured S	Max50	B6	B5	D5	CS88 M50	CS88LV	CS125/ CS126
CERRADURAS Y CERROJOS / LOCKS & RIM LOCKS	CS125 / CS126																	
	CS88LV																	
	CS88 M50																	
	D5																	
	B5																	
	B6																	
CANDADOS / PADLOCKS	Max50																	
	Armoured S																	
	Armoured																	
	Inox 50 / Cable Inox																	
	U 70/90																	
	K50																	
CILINDROS / CYLINDERS	Huno 80																	
	Titán																	
	F5S																	
	D																	
	M / M+ (Anti Snap)																	

### IMPORTANTE:

- 1) Además de estas compatibilidades, es importante reseñar que el candado 1030 combina con todas las series de cilindros, ya que se le puede acoplar cualquier medio cilindro europerfil.
- 2) Las llaves de los candados Armoured pueden abrir todos los productos con los que son compatibles, pero no a la inversa.

### IMPORTANT:

- 1) In addition to these compatibilities, it is important to mention that the 130 padlock is compatible with the cylinder series since any European profile cylinder can be used with it.
- 2) The keys for Armoured padlocks can open all compatible products, but not the other way around.



## Pedidos de llaves IFAM - IFAM key orders

### Candados

#### Alta seguridad - High Security

Ref.	Cod.	Uni.
Llave dentada Hercules / Hercules cut key	153256	1
Llave s/d bom. puntos (Hércules) / Dimple key blank (Hercules)	449160	1
Llave s/d Titán / Titan key blank	151762	
Llave dentada Titán / Titan cut key	153158	
Llave s/d Huno80 / Huno80 key blank	151762	
Llave dentada Huno80 / Huno80 cut key	153158	

#### Seguridad - Security

Ref.	Cod.	Uni.
Llave dentada S360 / S360 cut key	153247	1
Llave s/d cilindro oval (S360) / Oval cylinder cut key (S360)	460534	1
Llave s/d Serie U (perfil antig.) / U Series key blank (old profile)	151770	
Llave s/d Armoured S / Armoured S key blank	151761	50
Llave dentada Armoured S / Armoured Scout key	153158	
Llave s/d Armoured / Armoured key blank	151750	
Llave dentada Armoured / Armoured cut key	153140	
Llave s/d Serie U / U Series key blank	150450	
Llave dentada Serie U / U Series cut key	153080	

#### Serie K - K Series

Ref.	Cod.	Uni.
Llave s/d K15 / K15 key blank	150340	50
Llave dentada K15 / K15 cut key	153000	
Llave s/d K20 / K20 key blank	150360	50
Llave dentada K20 KA / K20 KA cut key	153052	
Llave s/d K25 / K25 key blank	150370	50
Llave dentada K25 KA / K25 KA cut key	153059	
Llave s/d K30 / K30 key blank	150390	50
Llave dentada K30 KA / K30 KA cut key	153066	
Llave s/d K40 / K40 key blank	150420	50
Llave dentada K40 KA / K40 KA cut key	153073	
Llave s/d K50 / K50 key blank	150450	50
Llave dentada K50 KA / K50 KA cut key	153080	
Llave s/d K60 / K60 key blank	150460	50
Llave dentada K60 KA / K60 KA cut key	153087	
Llave s/d K70 / K70 key blank	150460	50
Llave dentada K70 KA / K70 KA cut key	153087	

#### Diseño y combinación

Ref.	Cod.	Uni.
Llave s/d WP45 / WP45 key blank	151740	50
Llave s/d LM30 L / LM30 key blank	151718	50
Llave s/d LM40 L / LM40 key blank	151728	50
Llave s/d LM50 / LM50 key blank	151738	50
Llave s/d LM60 / LM60 key blank	151738	50
Llave s/d Circular / Circular key blank	449020	50

#### Serie Z - Z Series

Ref.	Cod.	Uni.
Llave s/d Z15 / Z15 key blank	150340	50
Llave dentada Z15 / Z15 cut key	153000	
Llave s/d Z20 / Z20 key blank	150350	50
Llave dentada Z20 KD / Z20 KD cut key	153007	
Llave dentada Z20 KA / Z20 KA cut key	153014	
Llave s/d Z25 / Z25 key blank	150380	50
Llave dentada Z25 KD / Z25 KD cut key	153020	
Llave dentada Z25 KA / Z25 KA cut key	153021	
Llave s/d Z35 / Z35 key blank	150410	50
Llave dentada Z35 / Z35 cut key	153028	
Llave dentada Z35 KA / Z35 KA cut key	153035	
Llave s/d Z45 / Z45 key blank	150440	50
Llave dentada Z45 / Z45 cut key	153042	
Llave dentada Z45 KA / Z45 KA cut key	153045	
Llave s/d Z55 / Z55 key blank	150440	50
Llave dentada Z55 / Z55 cut key	153042	
Llave dentada Z55 KA / Z55 KA cut key	153045	

#### Serie Tifón - Tifon Series

Ref.	Cod.	Uni.	Ref.	Cod.	Uni.
Llave s/d TF15 / TF15 key blank	151280	50	Llave s/d TF40 / TF40 key blank	151283	50
Llave dentada TF15 / TF15 cut key	153098		Llave dentada TF40 / TF40 cut key	153119	
Llave s/d TF20 / TF20 key blank	151280	50	Llave s/d TF50 / TF50 key blank	151284	50
Llave dentada TF20 / TF20 cut key	153098		Llave dentada TF50 / TF50 cut key	153126	
Llave s/d TF25 / TF25 key blank	151281	50	Llave s/d TF60 / TF60 key blank	151284	50
Llave dentada TF25 / TF25 cut key	153105		Llave dentada TF60 / TF60 cut key	153126	
Llave s/d TF30 / TF30 key blank	151282	50			
Llave dentada TF30 / TF30 cut key	153112				

#### Inox / Max 50

Ref.	Cod.	Uni.
Llave s/d Inox 30 / Inox30 key blank	150390	50
Llave dentada Inox30KA / Inox30KA cut key	153066	
Llave s/d Inox 40 / Inox40 key blank	150420	50
Llave dentada Inox40KA / Inox40KA cut key	153073	
Llave s/d Inox 50 / Inox50 key blank	150450	50
Llave dentada Inox50KA / Inox50KA cut key	153080	
Llave s/d Inox 60 / Inox60 key blank	150460	
Llave dentada Inox60KA / // Inox60KA cut key	153087	
Llave s/d Inox Top / InoxTop key blank	151995	
Llave dentada Inox top / InoxTop cut key	153270	
Llave s/d Inox Cable / InoxCable key blank	150450	50
Llave dentada Inox Cable / Inox Cable cut key	153080	
Llave s/d Max 50 / Max50 key blank	150450	50
Llave dentada Max50 / Max50 cut key	153080	

## Cilindros - Cylinders

Ref.	Cod.	Uni.
Llave dentada WX1000 / WX1000 cut key	900560	
Llave adicional WX1000 / WX1000 additional key	900555	
Llave dentada WX / WX cut key	900550	
Llave adicional WX / WX additional key	900540	
Llave s/d serie NK1000 / NK1000 key blank	151968	
Llave dentada serie NK1000 / NK1000 cut key	153244	
Llave s/d serie M2 / M2 key blank	151761	50
Llave dentada serie M2 / M2 cut key	153158	
Llave dentada Huno / Huno cut key	153300	
Llave adicional Huno	153305	
Llave dentada F5S / F5S cut key	153310	
Llave s/d F5S / F5S key blank	152004	
Llave s/d serie D / D Series key blank	151750	50
Llave dentada serie D / D Series cut key	153140	
Llave dentada serie D KA / D Series KA cut key	153147	
Llave s/d serie C / C Series key blank	151940	50

## Cerrojos y cerrad. - Locks & rim locks

Ref.	Cod.	Uni.
Llave dentada cerrad. C111 / C111 cam lock cut key	153091	
Llave s/d cerrad. C111 / C111 cam lock key blank	150470	50
Llave s/d D7 (Cerrojo CS70) / D7 (CS70 rim lock) key blank	151748	
Llave s/d cerrad. CS126 / C126 lock key blank	151750	50
Llave dentada cerrad. CS126 / CS125 lock cut key	153140	
Llave s/d cerrad. CS125 / CS125 lock key blank	151750	50
Llave dentada cerrad. CS125 / CS125 lock cut key	153140	
Llave s/d cerrojo B6 / B6 rim lock key blank	151761	
Llave dentada cerrojo B6 / B6 rim lock cut key	153080	
Llave s/d cerrojos B5 / D5 / B5 / D5 rim lock key blank	152004	
Llave dentada cerrojo B5 / D5 / B5 / D5 rim lock cut key	153310	
Llave s/d cerrojo CS88/CS88LV / CS88/CS88 LV rim lock key blank	151761	
Llave dentada CS88/CS88LV / CS88/CS88 LV rim lock cut key	153158	

## Antirrobo moto - Motorcycle locks

Ref.	Cod.	Uni.
Llave dentada antirrobo disco / Disc type cut key	151945	

## Seg. industrial - Industrial Safety

Ref.	Cod.	Uni.
Llave s/d SF40 / COL40 / SF40 / COL40 key blank	151935	
Llave dentada SF40 / COL40 / SF40 / COL40 cut key	153280	

### LLAVES IGUALES Y DE Nº DETERMINADO

KEYING ALIKE AND CERTAIN KEY NUMBER

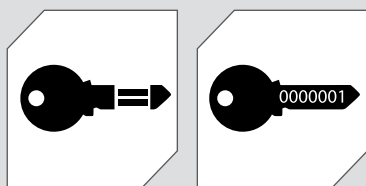

Otro de los servicios que ofrecemos a nuestros clientes es el servicio de llaves iguales, que permite abrir todas las cerraduras de una vivienda o negocio, por ejemplo, con una misma llave. Mediante el servicio de llaves de número determinado, se fabrican llaves iguales con un número concreto que aparece en la llave y que normalmente el cliente solicita.

Another service we offer our customers is the keyed alike service, which allows opening all the locks of a home or a business using a single key. The certain key number service is normally requested by the customer so IFAM manufactures additional locks or other products to the same key number which is a specific number engraved on the key.

### GRABADO LÁSER DE CANDADOS Y LLAVES

KEYING ALIKE AND CERTAIN KEY NUMBER



Mediante nuestro servicio de grabado láser, usted podrá personalizar los candados y llaves IFAM. Tanto empresas como particulares pueden solicitar que se grave en láser el logotipo, nombre, imagen o código alfanumérico que deseen. El grabado podrá realizarse en el cuerpo de los candados y en la cabeza de las llaves que solicite.

At IFAM Seguridad we offer an additional service to customise your padlocks and keys. Thanks to our laser engraving service, customers can ask for their company logo, name or any other image to be laser engraved on to the body of the padlock or the head of the keys.

Ref.	Cod.
Recargo Marcado laser llave / Laser engraving surcharge (Key)	900650
Recargo Marcado laser llave logo / Laser engraving surcharge (Logo on key)	900660
Recargo Marcado laser cuerpo / Laser engraving surcharge (Padlock's body)	900670
Recargo Marcado laser cuerpo logo / Laser engraving surcharge (Logo on padlock's body)	900680



### Expositor escudo D-fender

D-Fender escutcheon stand

N



Código / Code: 654358

### Expositor cartón para blister

Cardboard stand for blisters



Código / Code: 654339

Ref.	Cl.	Cod.	Uni.	Ref.	Cl.	Cod.	Uni.
<b>COL COMBI</b>				Col Combi 30	■	000614A	6
Col Combi 20	■	000612A	6	Col Combi 30	■	000614B	6
Col Combi 20	■	000612B	6	Col Combi 30	■	000614N	6
Col Combi 20	■	000612N	6	Col Combi 30	■	000614R	6
Col Combi 20	■	000612R	6	Col Combi 30	■	000614P	6
Col Combi 20	■	000612P	6	Col Combi 30	■	000614V	6
Col Combi 20	■	000612V	6	<b>SERIE CR - CR SERIES</b>			
				C25R		000615	12
				C35R		000617	12
				C45R		000619	12

### Expositor mirilla digital

Stand for digital door viewer



Código / Code:  
654355

Ref.	Cl.	Cod.	Uni.
Sentinel 4.0	■	067270	10
Sentinel 4.0	■	067250	10

### Expositor disco freno

Stand for brake disc locks



Código / Code: 654350



## Expositor 320x420

320x420 stand



Código / Code: 654340

Ref.	Cod.	Uni.	Ref.	Cod.	Uni.
<b>SERIE TIFON</b> TIFON SERIES			<b>SERIE K</b> K SERIES		
TF15	071500	24	K15	011500	12
TF20	072000	24	K20	012000	12
TF25	072500	12	K25	012500	12
TF30	073000	24	K30	013000	12
TF40	074000	30	K40	014000	12
TF50	075000	18	K50	015000	6
TF60	076000	12	K60	016000	6
TF20AL	072010	12	K20AL	012010	12
TF25AL	072510	12	K25AL	012510	12
TF30AL	073010	24	K30AL	013010	12
TF40AL	074010	24	K40AL	014010	12
TF50AL	074010	12	K50AL	015010	12

## Expositor 300x210

300x210 stand



Código / Code:  
654345

Ref.	Cod.	Uni.
<b>SERIE TIFON</b>		
TF20	072000	24
TF25	072500	12
TF30	073000	12
TF40	074000	12
TF50	075000	12
TF60	076000	6

## Expositor 1930x600x400

1930x600x400 stand



Código: 654365







# IFAM



IFAM WORLDWIDE

## GRUPO IFAM - Sede central

Notario Etxagibel, 4  
20500 Arrasate-Mondragón  
Gipuzkoa - SPAIN  
Tel.: +34 943 71 21 21  
Fax: +34 943 79 21 78  
[www.ifam.biz](http://www.ifam.biz)

## IFAM España

IFAM SEGURIDAD, S.L.U.  
Notario Etxagibel, 4  
20500 Arrasate-Mondragón  
Gipuzkoa  
Tel.: +34 943 71 21 21  
Fax: +34 943 79 21 78  
[www.ifam.es](http://www.ifam.es)  
[ifam@ifam.es](mailto:ifam@ifam.es)

## IFAM Francia

IFAM FRANCE SARL  
5, rue de Betnoms.  
33185. Le Haillan.  
Bordeaux  
Tel.: +33 05 56 559 688  
Fax: +33 05 56 559 368  
[www.ifamfrance.com](http://www.ifamfrance.com)  
[stocksud@ifamfrance.com](mailto:stocksud@ifamfrance.com)  
[stocknord@ifamfrance.com](mailto:stocknord@ifamfrance.com)  
[organigramme@ifamfrance.com](mailto:organigramme@ifamfrance.com)

## IFAM Reino Unido

SKS LTD.  
Unit 2 Canalside. Northbridge Road  
Berkhamsted (Hertfordshire)  
HP4 1EG  
Tel.: +44 1442 291 400  
[www.ifam.co.uk](http://www.ifam.co.uk)  
[info@ifam.co.uk](mailto:info@ifam.co.uk)

## IFAM Colombia

IFAM COLOMBIA, S.A.S.  
Diagonal 115A # 70B-45 Local 1  
Bogotá  
Tels.: +57 1 5333246  
+57 3203497446  
[www.ifam.com.co](http://www.ifam.com.co)  
[info@ifam.com.co](mailto:info@ifam.com.co)

Member of  
**Altuna Group**



[www.ifam.es](http://www.ifam.es)



8 420078 467857

