

# IFAM



**SUPLEMENTO GENERAL**  
GENERAL SUPPLEMENT

# SG.01

[www.ifam.es](http://www.ifam.es)



## Introducción

### Introduction

IFAM, calidad y servicio	
IFAM, quality & service	4
Simbología - Icon Index	6
Condiciones de venta - Sale conditions	7

## Cilindros

### Cylinders

Serie WX1000 - WX1000 Series	10
Serie M+ (Anti Snap) - M+ (Anti Snap) Series	12
Serie M - M Series	13
Serie F5S - F5S Series	14
Serie Huno - Huno Series	16
Serie D - D Series	16

## Cerrojos, Cerraduras y Escudos

### Rim locks, locks and escutcheons

Cerrojo CS88 M50/M70	
CS88 M50/M70 rim lock	18
Cerrojo CS200	
CS200 rim lock	18
Escudo D-Fender	
D-fender escutcheon	19

## Candados

### Padlocks

Armoured S	22
Col Combi 20	22
Rhin	23

## Seguridad industrial

### Industrial safety

SF40 Cable	26
COL40	26
Portacandados Multiple Arco Ø 4	
Multiple Hasp with Shackle Ø 4	27
Portacandados Multiple Cable Ø 4	
Cable lockout Ø 4	27
Portacandados Multiple Cable Ø 3 Plástico	
Multiple Hasp Lock Plastick cable Ø 3	28
Bloq. interno para interruptor magnetotérmico	
Thermal-magnetic circuit breaker lockout	28
Bloqueos válvulas de compuerta	
Gate valve lockouts	29
Estación almacenaje C	
Lockout station C	29

## Antirrobos para moto

### Motorcycle locks

Checkered Flag	32
Basic	32
Rookie	33
Storm Lock negro	
Storm Lock black	33
Master Disk	34

## Antirrobos para bicicleta

### Bicycle locks

Berlin	36
Kit Berlin + WP45	36

## La experiencia de un fabricante The experience from a manufacturing company

Fundada en 1948 en Mondragón (España), IFAM es líder en el mercado español de cerrajería. La empresa inició su actividad con la fabricación de candados, producto con el que consiguió un gran prestigio. Progresivamente, IFAM fue ampliando su línea de productos con la fabricación y comercialización de cerrojos, cerraduras, cilindros para puertas, antirrobo para moto y bicicleta y complementos de seguridad.

Established in 1948 in Mondragón (Spain), IFAM is the leader in the Spanish locksmith market. Since the very beginning the company produced padlocks and soon achieved prestige as a manufacturer. Progressively, IFAM expanded its product lines by manufacturing and selling locks, rim locks, door cylinders, motorcycle and bicycle locks and security complimentary products.



## Una amplia gama de servicios A wide range of services

Junto a un catálogo amplio y variado de productos, IFAM ofrece una gama muy diversa de servicios, con el fin de responder a las necesidades de sus clientes. En servicios de llaves, IFAM ofrece sus productos en llaves iguales, llaves desiguales, número determinado y amaestradas. Mediante el servicio de amaestramiento de llaves IFAM proporciona soluciones a medida para el sector de la construcción, centros educativos y deportivos colectividades...Además, IFAM es reconocida en el mercado por la agilidad de su servicio, que permite a sus clientes recibir sus pedidos en plazos muy cortos.

Besides a wide and varied catalogue of products, IFAM offers a very diverse range of services, in order to meet the customers' needs. Regarding services related to keys, IFAM offers its products keyed alike, keyed to differ, under a certain key number and master keyed. Through its master keying service, IFAM provides tailor-made solutions for the construction sector, sport and educational centers and communities. In addition, IFAM is recognized in the market for the agility of its service, which allows its customers to receive their orders on a very short deadline.



## Compromiso con la calidad y la innovación Commitment to quality and innovation

En IFAM, la búsqueda de la máxima calidad en sus productos y servicios es una constante. Prueba de ello son los certificados de calidad con los que cuenta, emitidos por entidades independientes, como las certificaciones ISO o las acreditaciones de su línea de cilindros para puertas, emitidas por los laboratorios Tecnalía.

Para alcanzar la máxima calidad, IFAM trabaja en desarrollos propios de producto en su departamento de Ingeniería. Así, la firma se adapta y se anticipa a las necesidades del mercado.

In IFAM, the search for the highest quality in our products and services is a constant. The company earned different quality certificates, issued by independent entities, such as ISO certifications or the accreditations of its line of cylinder doors, issued by Tecnalía laboratories.

To reach the highest quality, IFAM's Engineering department works in new product developments. Thus, the firm adapts and anticipates the needs of the market.



## Una marca presente en más de 50 países A brand present in more than 50 countries

La internacionalización de la marca es uno de los pilares estratégicos de IFAM, como así lo demuestra su implantación física en 4 países: España (donde se encuentra la sede central del Grupo IFAM, en Mondragón), IFAM Francia, IFAM Reino Unido e IFAM Colombia.

Gracias a sus filiales, una potente red de comercialización en crecimiento y la pertenencia a Altuna Group, líder internacional en el mercado cerrajero, los productos IFAM se hallan presentes en más de 50 países de los 5 continentes.

The international expansion of the brand is one of the strategic pillars of IFAM, as evidenced by its physical implementation in 4 countries: Spain (where the IFAM Group's headquarters are located in Mondragón), IFAM France, IFAM UK and IFAM Colombia.

Thanks to its subsidiaries, to a powerful growing network, and to being part of Altuna Group, a leader in the locksmith international market, the IFAM products are present in more than 50 countries on all 5 continents.





## Iconos - Icons

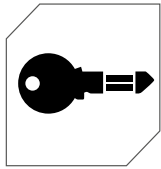

Llaves iguales  
Keyed alike

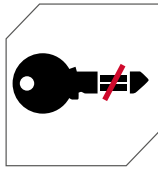

Llaves desiguales  
Keyed to differ

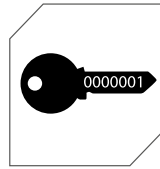

Llaves de nº determinado.  
Certain key number



Servicio de amaestramiento  
Master keying service



Solución de llave única  
Single key solution

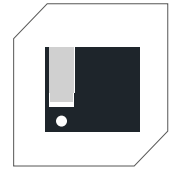

Disponible en medio cilindro  
Half cylinder available

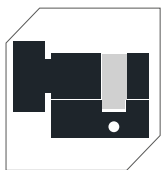

Disponible con pomo  
Thumb turn available

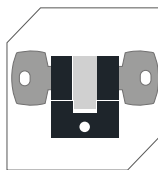

Cilindro de doble embrague  
Cylinder with emergency system

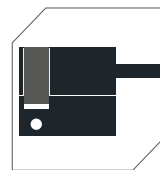

Disponible cilindro con eje regulable  
Cylinder with adjustable axis available

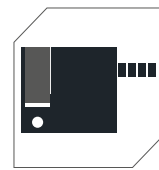

Disp.cilindro con lengüeta regulab.  
(barras antipánico)  
Cylinder with adjustable tab (for anti-panic bars)

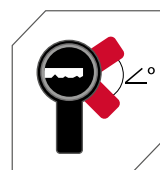

Cilindro ángulo de leva variable  
Cylinder with variable cam angle



Protección antibumping  
Bump proof protection



Protección antitaladro  
Anti-drill protection

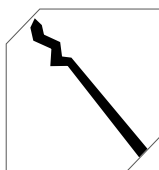

Protección antiganzúa  
Pick proof protections



Tarjeta de propiedad  
Property card



Servicio de grabado láser  
Laser engraving service



Candado con retención de llave  
Laser engraving service



Control de copia de llave  
Laser engraving service



Producto con alarma incorporada  
Product with alarm



Producto en caja  
Boxed product



Producto en blister  
Blister packed product

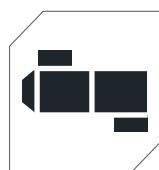

Producto sumin. en vitola de cartón  
Blister packed product

## Abreviaturas - Abbreviations

Estos son los significados de las abreviaturas que se muestran en los encabezamientos de las tablas:

- Ref.: referencia del producto.
- Cod.: código de producto.
- Uni.: unidades de producto por caja.
- €/uni.: precio por unidad.
- Cl.: color/acabado del producto.
- Pack: embalaje del producto.
- IPL: IFAM Protection Level. Escala IFAM de niveles de seguridad. Grado máximo: 10

These are the meanings of the abbreviations shown in the headings of the tables:

- Ref.: product reference.
- Cod.: product code.
- Uni.: product units per box.
- € / unit: price per unit.
- Cl.: color / finish of the product.
- Pack: product packaging.
- IPL: IFAM Protection Level. Maximum grade: 10

### Devoluciones y reposiciones - Returns and replacements

- No se aceptará devolución alguna de material sin autorización previa por parte de IFAM Seguridad, S.L.U. Si procede la devolución, el transporte se deberá realizar a través de la empresa de transporte indicada por IFAM Seguridad, S.L.U.
  - IFAM Seguridad, S.L.U. garantiza la calidad de sus productos. Ante posibles defectos de fabricación, IFAM Seguridad, S.L.U. se compromete a reponer el producto, no haciéndose cargo, en ningún caso, de cualquier otro tipo de gastos.
  - Las mercancías pertenecen a IFAM Seguridad, S.L.U. hasta el pago total por parte del cliente de la factura correspondiente.
- 
- No returns will be accepted without prior authorisation from IFAM Seguridad, S.L.U. If a return is warranted, the shipping shall be carried out using the shipping company indicated by IFAM Seguridad, S.L.U.
  - IFAM Seguridad, S.L.U. guarantees the quality of its products. In case of any possible manufacturing defect, IFAM Seguridad, S.L.U. will replace the product, being not liable for any other expense.
  - The goods belong to IFAM Seguridad, S.L.U. until the customer has paid the corresponding invoice in full.

### Modificaciones y recargos - Modifications and surcharges

- IFAM Seguridad, S.L.U. se reserva el derecho de descatalogar o modificar sus artículos cuando lo considere necesario.
  - Los artículos que se ofrecen en surtido de colores pueden suministrarse por color específico con un recargo.
  - Los candados pueden suministrarse con un marcado personalizado con un recargo.
- 
- IFAM Seguridad, S.L.U. reserves the right to discontinue or modify its products when deemed necessary.
  - The items offered in different colours can be supplied in a specific colour with a surcharge.
  - Locks may be supplied with a personalised marking with a surcharge.





# IFAM



## CILINDROS CYLINDERS

**SERIE WX1000**  
WX1000  
SERIES



PAG.  
10

**SERIE M+  
(ANTI SNAP)**  
M+ (ANTI  
SNAP) SERIES



PAG.  
12

**SERIE M**  
M SERIES



PAG.  
13

**SERIE F5S**  
F5S SERIES



PAG.  
14

**SERIE HUNO**  
HUNO  
SERIES



PAG.  
16

**SERIE D**  
D SERIES



PAG.  
16

## Serie WX1000 - WX1000 Series

- Cilindro perfil europeo de alta seguridad. Certificado según Norma EN:1303:2015.
  - Perfil con diseño patentado por IFAM (nº 2.061.242).
  - Cuerpo fabricado en latón extruido. Acabados en níquel y latón.
  - 16 pitones activos y amaestables, con millones de combinaciones.
  - Triple protección antibumping. Incluye un innovador sistema con doble pitón y doble muelle.
  - Puente reforzado antirrotura, fabricado en acero inoxidable y unido al cuerpo del cilindro por 4 pasadores de acero.
  - Máxima protección antitaladro con barras en el rotor y el cuerpo, coraza en la zona inferior y pitones adicionales de acero.
  - Protección antiganzúa.
  - Sistema de doble embrague: permite abrir cuando una llave bloquea el lado opuesto.
  - Se suministra con 5 llaves de alpaca con cabeza sobremoldeada en resina ABS para mayor comodidad de uso.
  - Incluye tarjeta de propiedad con el sistema de seguridad CCS (Control Code System). Máximo nivel de seguridad, control y trazabilidad de la copia de llaves para el usuario.
  - Llave compatible con cilindros Serie WX.
- High security euro profile cylinder. Certified to EN:1303:2015.
  - IFAM patented (no. 2.061.242) key profile
  - Extruded brass body. Nickel or brass finish.
  - 16 active pins, all of them able for master keying, with millions of differs.
  - Triple anti-bumping protection. Innovative double pin and double spring system included.
  - Reinforced anti-snap bar, made of stainless steel and attached to the body using four steel bolts.
  - Maximum anti-drill protection. Hardened pins fitted inside the front of the body and around the keyway.
  - Anti-pick protection.
  - Emergency system included: the cylinder allows opening the door even when a key blocks the other side of the lock.
  - Supplied with five nickel silver keys, with overmoulded head made from ABS resin for a more comfortable use.
  - Property card included with CCS (Control Code System). This system provides the user the maximum security and control of key duplications.
  - Key compatible with WX Series cylinders.

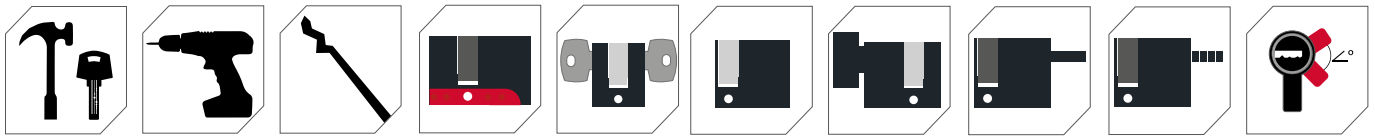

### PROTECCIÓN CONTRA LAS PRINCIPALES TENTATIVAS DE ROBO PROTECTION AGAINST THE MOST COMMON ROBBERY METHODS

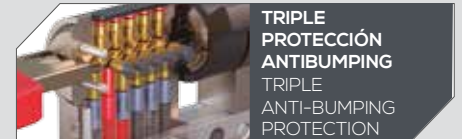

### CÓDIGO DE USO ÚNICO UNIQUE USAGE CODE

Junto con los cilindros WX1000 y WX, IFAM entrega una tarjeta de propiedad que incluye el código de copia de las llaves. Cada vez que el usuario solicita nuevas copias, IFAM renueva el código de la tarjeta de propiedad. A través del software Control Code System de IFAM, se genera un nuevo código. Los códigos antiguos quedan bloqueados y almacenados en el archivo histórico del cliente. Para garantizar la máxima confidencialidad, el nuevo código insertado en la nueva tarjeta queda enmascarado en una zona oculta y será invisible hasta que el usuario raspe en la zona para descubrir el código.

Along with the WX1000 and the WX cylinders, IFAM delivers an ownership card that includes the key copy code. Each time the user requests new copies, IFAM renews the code on the ownership card. A new code is generated through IFAM's software Control Code System. The old codes will be blocked and stored in the customers history file. In order to guarantee the maximum confidentiality, the new code printed on the card will be masked in a hidden area and will remain invisible until the user scratches the area to reveal the code.



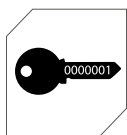
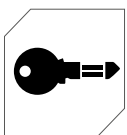
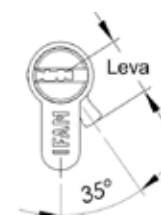
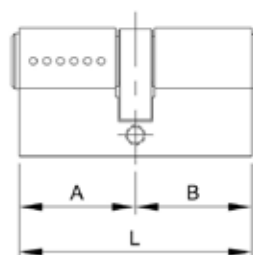

Cod. 900295

Cod. 900295

Cod. 900205

## PERFIL PATENTADO PATENTED PROFILE



El perfil patentado WX de IFAM le proporciona un extra de seguridad a su cilindro, en lo que al control de las copias de llave se refiere.

Sólo IFAM y los profesionales autorizados por la marca pueden realizar copias de llave de los cilindros WX1000 y WX.

IFAM's WX patented profile provides extra security to your cylinder, when it comes to key duplications.

Only IFAM and the professionals authorized by the brand can make key copies of the WX1000 and WX cylinders' keys.

Ref.	Cod.	Cl.	A	A	B	Uni.
<b>LEVA CAM: 15mm. Pack. </b>						
1000WX1030L	060100		40	10	30	6
1000WX1030N	060110		40	10	30	6
1000WX3030L	060200		60	30	30	6
1000WX3030N	060210		60	30	30	6
1000WX3035N	060310		65	30	35	6
1000WX3040L	060400		70	30	40	6
1000WX3040N	060410		70	30	40	6
1000WX3045L	060500		75	30	45	6
1000WX3045N	060510		75	30	45	6
1000WX3050N	060610		80	30	50	6
1000WX3060N	060810		90	30	60	6
1000WX3070N	060910		100	30	70	6
1000WX3535L	061000		70	35	35	6
1000WX3535N	061010		70	35	35	6
1000WX3540N	061110		75	35	40	6
1000WX3545N	061170		80	35	45	6
1000WX4040L	061400		80	40	40	6
1000WX4040N	061410		80	40	40	6
1000WX4050N	061610		90	40	50	6
1000WX4060N	061710		100	40	60	6
1000WX4545N	061810		90	45	45	6
<b>LEVA CAM: 13mm. Pack. </b>						
1000WX3030LC	060250		60	30	30	6
1000WX3030NC	060260		60	30	30	6
1000WX3040LC	060450		70	30	40	6
1000WX3040NC	060460		70	30	40	6

Ref.	Cod.	Cl.	A	A	B	Uni.
1000WX3535LC	061050		70	35	35	6
1000WX3535NC	061060		70	35	35	6
1000WX4040LC	061450		80	40	40	6
1000WX4040NC	061460		80	40	40	6
<b>LEVA CAM: 15mm.. Pack. </b>						
1000WX3030L	060201		60	30	30	6
1000WX3030N	060211		60	30	30	6
1000WX3040L	060401		70	30	40	6
1000WX3040N	060411		70	30	40	6
1000WX3535L	061001		70	35	35	6
1000WX3535N	061011		70	35	35	6
1000WX4040L	061401		80	40	40	6
1000WX4040N	061411		80	40	40	6
<b>LEVA CAM: 13mm. Pack. </b>						
1000WX3030LC	060251		60	30	30	6
1000WX3030NC	060261		60	30	30	6
1000WX3040LC	060451		70	30	40	6
1000WX3040NC	060461		70	30	40	6
1000WX3535LC	061051		70	35	35	6
1000WX3535NC	061061		70	35	35	6
1000WX4040LC	061451		80	40	40	6
1000WX4040NC	061461		80	40	40	6

Ver pag. siguiente / See next page

## Serie WX1000 - WX1000 Series

Ref.	Cod.	Cl.	A	A	B	Uni.
<b>POMO THUMB TURN. LEVA CAM: 15mm. Pack. </b>						
1000WXP3030L	060202		60	30	30	6
1000WXP3040L	060402		70	30	40	6
1000WXP3040N	060412		70	30	40	6
1000WXP3535L	061002		70	35	35	6
1000WXP3535N	061012		70	35	35	6
1000WXP4040L	061402		80	40	40	6
1000WXP4040N	061412		80	40	40	6
<b>POMO THUMB TURN. LEVA CAM: 13mm. Pack. </b>						
1000WXP3030LC	060252		60	30	30	6
1000WXP3030NC	060262		60	30	30	6
1000WXP3040LC	060452		70	30	40	6
1000WXP3040NC	060462		70	30	40	6
1000WXP3535LC	061052		70	35	35	6
1000WXP3535NC	061062		70	35	35	6
1000WXP4040LC	061452		80	40	40	6
1000WXP4040NC	061462		80	40	40	6



**CILINDRO DE EJE REGULABLE**  
CYLINDER WITH ADJUSTABLE AXIS

Ref.	Cod.	Cl.	L	A	B	Uni.
<b>LEVA CAM: 15mm. Pack. </b>						
1000WXE3030L	060206		60	30	30	1
1000WXE3030N	060216		60	30	30	1
1000WXE3035N	060316		65	30	35	1
1000WXE3040L	060406		70	30	40	1
1000WXE3040N	060416		70	30	40	1
1000WXE3045L	060506		75	30	45	1
1000WXE3045N	060516		75	30	45	1
1000WXE3050N	060616		80	30	50	1
1000WXE3060N	060716		90	30	60	1
1000WXE3070N	060816		100	30	70	1



**CILINDRO DE LENGÜETA REGULABLE (PARA BARRAS ANTIPÁNICO)**  
CYLINDER WITH ADJUSTABLE TAB (FOR ANTI-PANIC BARS)

Ref.	Cod.	Cl.	L	A	B	Uni.
<b>LEVA CAM: 15mm. Pack. </b>						
1000WX1030LR	060108		40	10	30	1
1000WX1030NR	060118		40	10	30	1



**CILINDRO DE LEVA REGULABLE**  
CYLINDER WITH ADJUSTABLE CAM

Ref.	Cod.	Cl.	L	A	B	Uni.
<b>LEVA CAM: 15mm. Pack. </b>						
1000WX1030LA	060103		40	10	30	1
1000WX1030NA	060113		40	10	30	1

## Serie M+ (Anti Snap) - M+ (Anti Snap) Series



**CILINDRO DE EJE REGULABLE**  
CYLINDER WITH ADJUSTABLE AXIS

Ref.	Cod.	Cl.	L	A	B	Uni.
<b>LEVA CAM: 15mm. Pack. </b>						
ME3030SL	037306		60	30	30	1
ME3030SN	037326		60	30	30	1
ME3040SL	037336		70	30	40	1
ME3040SN	037356		70	30	40	1
ME3050SL	037366		80	30	50	1
ME3050SN	037386		80	30	50	1



## Serie M - M Series



Ref.	Cod.	Cl.	L	A	B	Uni.
<b>DOBLE EMBRAGUE. EMERGENCY SYSTEM</b>						
<b>LEVA CAM: 15mm Pack. </b>						
M3030LD	035220	■	60	30	30	1
M3030ND	035230	■	60	30	30	1
M3035LD	035320	■	65	30	35	1
M3035ND	035330	■	65	30	35	1
M3040LD	035420	■	70	30	40	1
M3040ND	035430	■	70	30	40	1
M3535LD	036020	■	70	35	35	1
M3535ND	036030	■	70	35	35	1
M3045LD	035520	■	75	30	45	1
M3045ND	035530	■	75	30	45	1
M3540LD	036120	■	75	35	40	1
M3540ND	036130	■	75	35	40	1
M3050LD	035620	■	80	30	50	1
M3050ND	035630	■	80	30	50	1
M3545LD	037120	■	80	35	45	1
M3545ND	037130	■	80	35	45	1
M4040LD	036420	■	80	40	40	1
M4040ND	036430	■	80	40	40	1
M3550LD	037220	■	85	35	50	1
M3550ND	037230	■	85	35	50	1
M3060LD	035820	■	90	30	60	1

Ref.	Cod.	Cl.	L	A	B	Uni.
M3060ND	035830	■	90	30	60	1
M4050LD	036620	■	90	40	50	1
M4050ND	036630	■	90	40	50	1
M4545LD	036820	■	90	45	45	1
M4545ND	036830	■	90	45	45	1
M3070LD	035920	■	100	30	70	1
M3070ND	035930	■	100	30	70	1
M4060LD	036720	■	100	40	60	1
M4060ND	036730	■	100	40	60	1
M5050LD	036920	■	100	50	50	1
M5050ND	036930	■	100	50	50	1
M5060LD	036986	■	110	50	60	1
M5060ND	036987	■	110	50	60	1
M6060LD	036996	■	120	60	60	1
M6060ND	037010	■	120	60	60	1
<b>DOBLE EMBRAGUE. EMERGENCY SYSTEM</b>						
<b>LEVA CAM: 13mm Pack. </b>						
M3030LCD	035270	■	60	30	30	1
M3030NCD	035280	■	60	30	30	1
M3035LCD	035370	■	65	30	35	1
M3035NCD	035380	■	65	30	35	1
M3040LCD	035470	■	70	30	40	1
M3040NCD	035480	■	70	30	40	1

Ref.	Cod.	Cl.	L	A	B	Uni.
M3535LCD	036070	■	70	35	35	1
M3535NCD	036080	■	70	35	35	1
M3045LCD	035570	■	75	30	45	1
M3045NCD	035580	■	75	30	45	1
M3540LCD	036170	■	75	35	40	1
M3540NCD	036180	■	75	35	40	1
M3050LCD	035670	■	80	30	50	1
M3050NCD	035680	■	80	30	50	1
M3545LCD	037170	■	80	35	45	1
M3545NCD	037180	■	80	35	45	1
M4040LCD	036470	■	80	40	40	1
M4040NCD	036480	■	80	40	40	1
M3550LCD	037270	■	85	35	50	1
M3550NCD	037280	■	85	35	50	1
M3060LCD	035870	■	90	30	60	1
M3060NCD	035880	■	90	30	60	1
M4050LCD	036670	■	90	40	50	1
M4050NCD	036680	■	90	40	50	1
M3070LCD	035970	■	100	30	70	1
M3070NCD	035980	■	100	30	70	1
M4060LCD	036770	■	100	40	60	1
M4060NCD	036780	■	100	40	60	1
M5050LCD	036966	■	100	50	50	1
M5050NCD	036967	■	100	50	50	1



**CILINDRO DE  
 EJE REGULABLE**  
 CYLINDER WITH  
 ADJUSTABLE AXIS

Ref.	Cod.	Cl.	L	A	B	Uni.
<b>LEVA CAM: 15mm. Pack. </b>						
ME3030L	035206	■	60	30	30	1
ME3030N	037316	■	60	30	30	1
ME3035L	035306	■	65	30	35	1
ME3035N	035316	■	65	30	35	1
ME3040L	035406	■	70	30	40	1
ME3040N	037346	■	70	30	40	1

Ref.	Cod.	Cl.	L	A	B	Uni.
ME3045L	035506	■	75	30	45	1
ME3045N	035516	■	75	30	45	1
ME3050L	035606	■	80	30	50	1
ME3050N	037376	■	80	30	50	1
ME3060L	035806	■	90	30	60	1
ME3060N	035816	■	90	30	60	1
ME3070L	035906	■	100	30	70	1
ME3070N	035916	■	100	30	70	1

## Serie F5S - F5S Series

- Cilindro perfil europeo.
  - Cuerpo y tambor fabricados en latón extruido.
  - 5 pitones con miles de combinaciones.
  - Pitones antitaladro.
  - Muelles en acero inoxidable.
  - Acabados en níquel y latón.
  - Se suministra con 3 llaves de serreta.
- European profile cylinder.
  - Brass body and barrel.
  - 5 pins with thousands of differs.
  - Drill resistant pins.
  - Stainless steel springs.
  - Brass and nickel finishes.
  - Supplied with 3 standard keys.

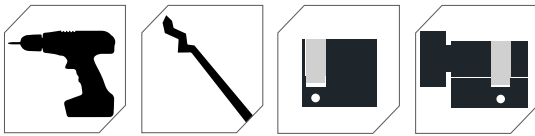

Ref.	Cod.	Cl.	L	A	B	Uni.
<b>LEVA CAM: 15mm. Pack. </b>						
F5S1030L	038000		40	10	30	6
F5S1030N	038020		40	10	30	6
F5S1035L	038040		45	10	35	6
F5S1035N	038060		45	10	35	6
F5S1040L	038080		50	10	40	6
F5S1040N	038100		50	10	40	6
F5S1045L	038120		55	10	45	6
F5S1045N	038140		55	10	45	6
F5S1050L	038160		60	10	50	6
F5S1050N	038180		60	10	50	6
F5S1055L	038200		65	10	55	6
F5S1055N	038220		65	10	55	6
F5S1060L	038240		70	10	60	6
F5S1060N	038260		70	10	60	6
F5S1070L	038280		80	10	70	6
F5S1070N	038300		80	10	70	6
F5S1080L	038320		90	10	80	6
F5S1080N	038340		90	10	80	6

Ref.	Cod.	Cl.	L	A	B	Uni.
F5S3030L	038360		60	30	30	6
F5S3030N	038380		60	30	30	6
F5S3035L	038400		65	30	35	6
F5S3035N	038420		65	30	35	6
F5S3040L	038460		70	30	40	6
F5S3040N	038480		70	30	40	6
F5S3045L	038500		75	30	45	6
F5S3045N	038520		75	30	45	6
F5S3050L	038540		80	30	50	6
F5S3050N	038560		80	30	50	6
F5S3055L	038580		85	30	55	6
F5S3055N	038600		85	30	55	6
F5S3060L	038620		90	30	60	6
F5S3060N	038640		90	30	60	6
F5S3070L	038660		100	30	70	6
F5S3070N	038680		100	30	70	6
F5S3080L	038700		110	30	80	6
F5S3080N	038720		110	30	80	6
F5S3090L	038740		120	30	90	6
F5S3090N	038760		120	30	90	6

Ref.	Cod.	Cl.	L	A	B	Uni.
F5S3535L	038780		70	35	35	6
F5S3535N	038800		70	35	35	6
F5S3540L	038820		75	35	40	6
F5S3540N	038840		75	35	40	6
F5S3545L	038860		80	35	45	6
F5S3545N	038880		80	35	45	6
F5S3550L	038900		85	35	50	6
F5S3550N	038920		85	35	50	6
F5S3555L	038940		90	35	55	6
F5S3555N	038960		90	35	55	6
F5S4040L	038980		80	40	40	6
F5S4040N	039000		80	40	40	6
F5S4045L	039020		85	40	45	6
F5S4045N	039040		85	40	45	6
F5S4050L	039060		90	40	50	6
F5S4050N	039080		90	40	50	6
F5S4060L	039100		100	40	60	6
F5S4060N	039120		100	40	60	6
F5S4545L	039140		90	45	45	6
F5S4545N	039160		90	45	45	6

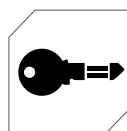

Cod. 900280

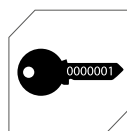

Cod. 900280



Cod. 900120

Ref.	Cod.	Cl.	L	A	B	Uni.
F5S5050L	039180	■	100	50	50	6
F5S5050N	039200	■	100	50	50	6
F5S5060L	039220	■	110	50	60	6
F5S5060N	039240	■	110	50	60	6
<b>POMO THUMB TURN. LEVA CAM: 15mm.</b>						
<b>Pack.</b>						
F5SP1030L	038002	■	40	10	30	6
F5SP1040L	038082	■	40	10	40	6
F5SP1040N	038102	■	50	10	40	6
F5SP3030L	038362	■	60	30	30	6
F5SP3030N	038382	■	60	30	30	6
F5SP3040L	038462	■	70	30	40	6
F5SP3040N	038482	■	70	30	40	6
F5SP3050L	038542	■	80	30	50	6
F5SP3050N	038560	■	80	30	50	6
F5SP3060L	038622	■	90	30	60	6
F5SP3060N	038642	■	90	30	60	6
F5SP3535L	038782	■	70	35	35	6
F5SP3535N	038802	■	70	35	35	6
F5SP4040L	038982	■	80	40	40	6

Ref.	Cod.	Cl.	L	A	B	Uni.
F5SP4040N	039002	■	80	40	40	6
F5SP4050L	039062	■	90	40	50	6
F5SP4050N	039082	■	90	40	50	6
F5SP4060L	039102	■	100	40	60	6
F5SP4060N	039122	■	100	40	60	6
F5SP5050L	039182	■	100	50	50	6
F5SP5050N	039202	■	100	50	50	6
F5SP3530L	039302	■	65	35	30	6
F5SP3530N	039312	■	65	35	30	6
F5SP4030L	039322	■	70	40	30	6
F5SP4030N	039332	■	70	40	30	6
F5SP4535L	039342	■	80	45	35	6
F5SP4535N	039352	■	80	45	35	6
F5SP5040L	039362	■	90	50	40	6
F5SP5040N	039372	■	90	50	40	6
F5SP6030L	039382	■	90	60	30	6
F5SP6030N	039392	■	90	60	30	6
F5SP6040L	039402	■	100	60	40	6
F5SP6040N	039412	■	100	60	40	6



## Serie Huno - Huno Series

**+** INFO | CATÁLOGO GENERAL  
PAG 21 | GENERAL CATALOGUE



**CILINDRO DE EJE REGULABLE**  
CYLINDER WITH ADJUSTABLE AXIS



**CILINDRO DE LENGÜETA REGULABLE (PARA BARRAS ANTIPÁNICO)**  
CYLINDER WITH ADJUSTABLE TAB (FOR ANTI-PANIC BARS)



**CILINDRO DE LEVA REGULABLE**  
CYLINDER WITH ADJUSTABLE CAM

Ref.	Cod.	Cl.	L	A	B	Uni.
<b>LEVA CAM: 15mm. Pack.</b>						
HunoE3030N	001306		60	30	30	1
HunoE3040N	001316		70	30	40	1
HunoE3050N	001326		80	30	50	1

Ref.	Cod.	Cl.	L	A	B	Uni.
<b>LEVA CAM: 15mm. Pack.</b>						
Huno1030NR	001108		40	10	30	1
Huno1040NR	001118		50	10	40	1

Ref.	Cod.	Cl.	L	A	B	Uni.
<b>LEVA CAM: 15mm. Pack.</b>						
Huno1030NA	001113		40	10	30	1
Huno1040NA	001123		50	10	40	1

## Serie D - D Series

**+** INFO | CATÁLOGO GENERAL  
PAG 22 | GENERAL CATALOGUE



**CILINDRO DE EJE REGULABLE**  
CYLINDER WITH ADJUSTABLE AXIS



**CILINDRO DE LENGÜETA REGULABLE (PARA BARRAS ANTIPÁNICO)**  
CYLINDER WITH ADJUSTABLE TAB (FOR ANTI-PANIC BARS)



**CILINDRO DE LEVA REGULABLE**  
CYLINDER WITH ADJUSTABLE CAM

Ref.	Cod.	Cl.	L	A	B	Uni.
<b>LEVA CAM: 15mm. Pack.</b>						
DE3030L	031306		60	30	30	1
DE3030N	031316		60	30	30	1
DE3040L	031606		70	30	40	1
DE3040N	031616		70	30	40	1
DE3050L	031906		80	30	50	1
DE3050N	031916		80	30	50	1

Ref.	Cod.	Cl.	L	A	B	Uni.
<b>LEVA CAM: 15mm. Pack.</b>						
D1030LR	031008		40	10	30	1
D1030NR	031018		40	10	30	1
D1040LR	032608		50	10	40	1
D1040NR	032618		50	10	40	1

Ref.	Cod.	Cl.	L	A	B	Uni.
<b>LEVA CAM: 15mm. Pack.</b>						
D1030LA	031003		40	10	30	1
D1030NA	031013		40	10	30	1
D1040LA	031103		50	10	40	1
D1040NA	031113		50	10	40	1



## CERROJOS Y ESCUDOS RIM LOCKS & ESCUTCHEONS

**CS88  
M50/M70**



PAG.  
18

**CS200**



PAG.  
18

**D-FENDER**



PAG.  
19

## CS88M50 / CS88 M70

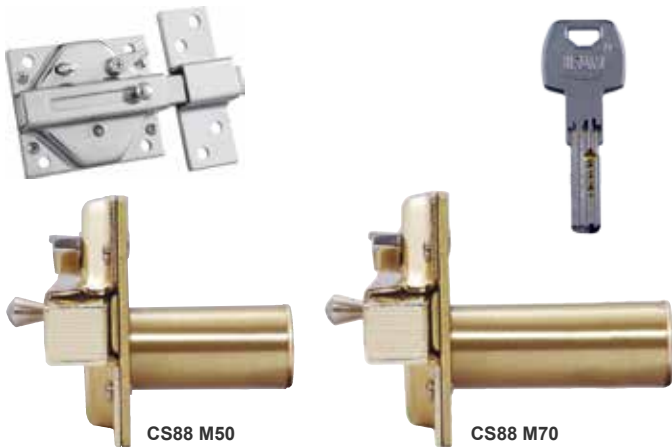

- Palanca de acero cuadrado de 17 mm.
- Condena de palanca desde el interior. Esta opción es desactivable si el cliente lo especifica en su pedido.
- Incluye cilindro. Dos opciones: 50 mm. ó 70 mm. de largo.
- Utilizable para puertas de apertura izquierda o derecha.
- Acabado latonado y cromo satinado.
- Llave compatible con: cilindros Serie M+ (Anti snap) y Serie M; candados Titán, Huno 80 y Armoured S; cerrojos CS88LV y B6/50.

- 17mm steel square handle.
- Handle seal from inside; this option can be deactivated under customer's request.
- Cylinder included. Two options: 50mm or 70mm long.
- Can be used on left-hand and right-hand doors.
- Brass and polished nickel plated finish.
- Key compatible with: M+ (Anti Snap) Series and M Series cylinders, Titan and Huno 80 padlocks and CS88LV and B6/50 rim locks.

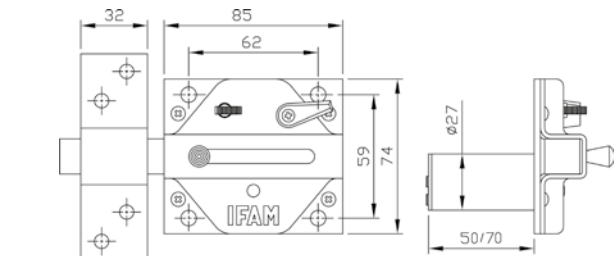
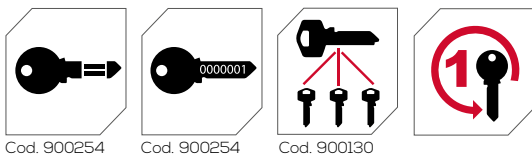

Ref.	CL.	Cod.	IPL		Pack	Uni.
CS88L M50	■	025206	8			1
CS88SC M50	■	025236	8			1
CS88L M70	■	025208	8			1
CS88SC M70	■	025238	8			1

## CS200



\* Cilindro no incluido  
Supplied without cylinder

- Cerrojo diseñado para la instalación de cualquier cilindro europerfil.
- La propia leva del cilindro acciona la palanca del cerrojo. No es necesario cambiar la leva del cilindro por una leva de corona.
- Cuerpo fabricado en acero.
- Acabados en níquel y latón, con una alta resistencia al desgaste y la corrosión.
- Compatible con escudos con distancia entre ejes de 26 ó 38 mm., como todos los disponibles en la gama IFAM.
- Para saber la longitud del cilindro que necesita instalar con el cerrojo CS200 en su puerta, realice la siguiente suma: 30 mm + 10 mm + espesor de su puerta en milímetros.

- Rim lock designed for installing any euro profile cylinder
- The cylinder cam activates the deadbolt lever directly, so there is no need to be replaced with a crown-shaped cam.
- Steel body.
- Brass and nickel finishes, highly resistant to wear and corrosion.
- Compatible with door escutcheons with a distance between axes of 26 or 38 mm, like the ones in the IFAM range.
- In order to know the length of the cylinder you have to instal in the CS200 rim lock, please make the following sum: 30 mm + 10 mm + the door's thickness in millimetres.

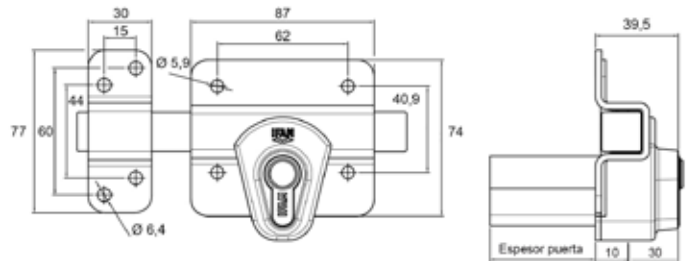

Ref.	CL.	Cod.	IPL	Pack	Uni.
CS200L	■	025310			1
CS200C	■	025320			1

## D-fender



- Escudo de alta seguridad.
- Formado por un sólido conjunto de núcleo y coraza exterior, ambos fabricados en acero macizo y templado, con un espesor en la zona central de 15 mm.
- Núcleo con nivel de seguridad certificado según norma EN:1303:2015. Incluye bocallaves de acero templado de 4 mm. de espesor para una máxima protección antitaladro.
- Forma especialmente diseñada y testada por IFAM para impedir los ataques con herramientas de extracción.
- Tetones de acero de instalación opcional. Incluidos para reforzar la seguridad ante tentativas de giro y extracción del escudo.
- Incluye arandela suplementaria para el ajuste idóneo del núcleo del escudo, en función del grosor de la puerta.
- El núcleo del escudo se fija a la puerta de manera independiente a la coraza exterior. En caso de una extracción forzada de la coraza, sería necesaria una nueva tentativa para extraer el núcleo del escudo.
- Disponible en 2 tamaños (D-fender 100 y D-fender 200) y dos acabados: latón y cromo.
- Acabado con tratamiento de galvanoplastia para proteger el escudo de rozaduras y de la corrosión.
- High security door escutcheon.
- Solid core and outer shell unit, both made of solid tempered steel and 15 mm thick through the centre.
- Core with EN:1303:2015 security standard certification. Includes 4 mm tempered steel keyhole cover for ultra high anti-drilling resistance.
- Shape specially designed and tested by IFAM to stop attacks with extraction tools
- Optional steel installation dowels included to reinforce security against torsion and face plate extraction attacks
- Includes an extra washer so the core can be fitted perfectly into the face plate depending on the thickness of the door
- The escutcheon's core is attached to the door independently from the outer shell. In the event of a forced shell extraction, another attack would be required to remove the face plate core.
- Available in 2 sizes, D-Fender 100 and D-Fender 200, and 2 finishes, brass and chrome.
- Electrotype treated finish to protect the face plate from scratches and corrosion.

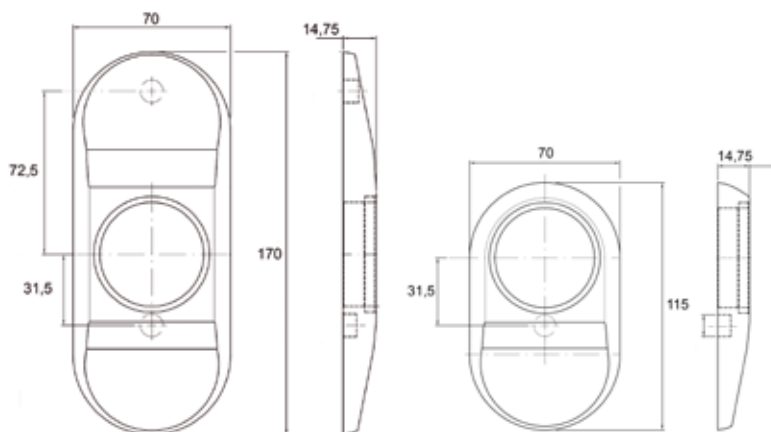

Ref.	CL.	Cod.	IPL	Pack	Uni.
D-fender 100 CM	■	025042	10	📦	1
D-fender 100 L	■	025040	10	📦	1
D-fender 200 CM	■	025046	10	📦	1
D-fender 200 L	■	025044	10	📦	1





## CANDADOS PADLOCKS

**ARMoured  
S**



PAG.  
22

**COL COMBI  
20**



PAG.  
22

**RHIN**



PAG.  
23



### Armoured S

**+** INFO | CATÁLOGO GENERAL  
PAG 42 | GENERAL CATALOGUE



- Norma EN12320 con Grado 4.
- Cuerpo de latón cubierto de coraza de acero endurecido y cromado.
- Condena de acero endurecido y cromado.
- Cilindro de latón con protección anti-taladro.
- Se suministran con 2 llaves de puntos de seguridad.
- Llave compatible con cilindros Serie M+ (Anti Snap) y Serie M; candados Titán y Huno 80; cerrojos CS88 M50/M70, CS88 LV y B6/50.

- Standard EN12320 Grade 4.
- Brass body covered by a hardened and chrome plated casing.
- Hardened and chrome plated steel lock.
- Brass cylinder with drill resistant protection.
- Supplied with 2 security dimple keys.
- Key compatible with: M+ (Anti Snap) and M Series cylinders; Titan and Huno 80 padlocks; CS88 M50/M70, CS88 LV and B6/50 rim locks.

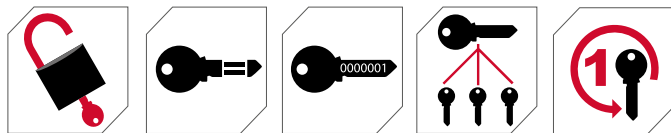

Cod. 900130

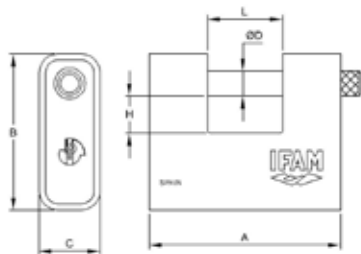

Ref.	Cod.	IPL	A	B	C	D	L	H		Pack	Uni.
ARM80 S	052180	8	82	69	29	11	30	14			6
ARM80 S	052181	8	82	69	29	11	30	14			3
ARM80 S KN	052187	8	82	69	29	11	30	14			6
ARM90 S	052190	8	91,7	75	29,2	12	35,7	18			6
ARM90 S	052191	8	91,7	75	29,2	12	35,7	18			3
ARM90 S KN	052197	8	91,7	75	29,2	12	35,7	18			6

### Col Combi 20

**+** INFO | CATÁLOGO GENERAL  
PAG 56 | GENERAL CATALOGUE



- Cuerpo en aluminio, que aporta una gran ligereza a los candados.
- Arco de acero cromado de 3 mm. de diámetro.
- Apertura y cierre de combinación con 3 rodillos. 1.000 combinaciones a elegir.
- Disponible en 6 colores: negro, azul, amarillo, violeta, verde y rojo.
- Ideal para taquillas de gimnasios, colegios, centros de trabajo...

- Aluminium body, which brings great lightness to these padlocks.
- Steel chromed shackle. Diameter: 3 mm.
- 3-dial combination locking: 1.000 differs to choose.
- Available in 6 colours: black, blue, yellow, violet, green and red.
- Ideal for gym, school and workplace's lockers...

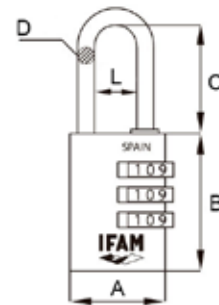

Ref.	Cl.	Cod.	A	B	C	D	E	IPL	Pack	Uni.
Col Combi 20		000612A	21	30	21	3	9,5	5		6
Col Combi 20		000612B	21	30	21	3	9,5	5		6
Col Combi 20		000612N	21	30	21	3	9,5	5		6
Col Combi 20		000612R	21	30	21	3	9,5	5		6
Col Combi 20		000612P	21	30	21	3	9,5	5		6
Col Combi 20		000612V	21	30	21	3	9,5	5		6



## Rhin



- Candado tipo alemán.
- Cuerpo de latón fundido.
- Arco de acero endurecido.
- Diámetro de arco: 8 mm.
- Se suministra con 2 llaves.

- German type padlock.
- Cast brass body.
- Hardened steel shackle.
- Shackle diameter: 8 mm.
- Supplied with 2 keys.

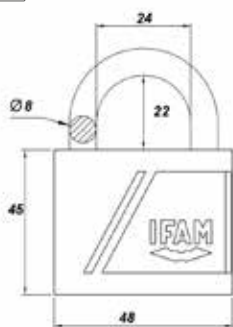
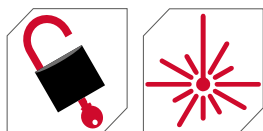

Ref.	Cod.	IPL		Pack	Uni.
Rhin 40	018400	7			6
Rhin 40 KN	018407	7			6





## SEGURIDAD INDUSTRIAL INDUSTRIAL SAFETY

SF40 CABLE



PAG. 26

COL40



PAG. 26

PORT. MÚLTIPLE  
ARCO Ø 4

MULTIPLE HASP  
WITH SHACKLE Ø 4



PAG. 27

PORT. MÚLTIPLE  
CABLE Ø 4

CABLE LOCKOUT  
Ø 4



PAG. 27

PORT. MÚLTIPLE  
CABLE Ø3 PLÁSTICO

MULTIPLE HASP LOCK  
PLASTIC CABLE Ø3



PAG. 28

BLOQUEO INTERR.  
MAGNETOTÉRMICO

THERM-MAGN. CIRCUIT  
BREAKER LOCKOUT



PAG. 28

BLOQUEOS VÁLVU-  
LAS DE COMPUERTA

GATE VALVE  
LOCKOUT



PAG. 29

ESTACION  
ALMACENAJE C

LOCKOUT  
STATION C



PAG. 29

## SF40 Cable

**+** INFO | CATÁLOGO GENERAL  
PAG 64 | GENERAL CATALOGUE



- Cuerpo fabricado en polímero altamente aislante ABS.
- Resistente a impactos, rayos ultravioleta, corrosión y temperaturas extremas. Diámetro del cable 3,4 mm., apto para dispositivos de bloqueo con orificios de diámetro máximo de 6,5mm.
- Candado recomendado para bloquear maquinaria cuando el acceso a la zona de bloqueo es complicada por falta de espacio.
- Sistema de retención de llave con el candado abierto.
- Incluye pegatinas para señalización de la zona peligrosa que el candado protege.
- Se suministra con 1 llave. Llave compatible con candados Col40.
- 4 colores disponibles: rojo, azul, verde, amarillo.

- Body made of highly insulating polymer ABS.
- Shock, UV-ray, corrosion and extreme temperature resistant. Cable diameter of 3.4 mm. This padlock is ideal for blocking lockout devices with holes up to 6.5mm in diameter
- Recommended for places where blocking the industrial equipment is complicated due to lack of space.
- Key retention system when the padlock is open.
- Includes stickers for signaling the danger zone protected by the padlock.
- Supplied with 1 key. Key compatible with Col40 padlocks.
- 6 colors available: red, blue, green, yellow, black and orange.

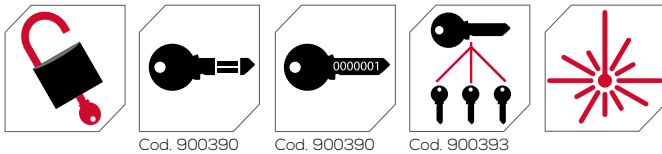

Cod. 900390

Cod. 900390

Cod. 900393

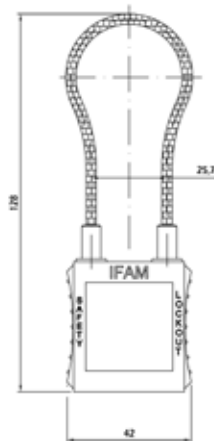

Ref.	Cl.	Cod.		Pack	Uni.
SF40 Cable	■	044950			10
SF40 Cable	■	044951			10
SF40 Cable	■	044952			10
SF40 Cable	■	044953			10

## Col40



- Cuerpo de aluminio anodizado y arco de acero endurecido.
- Cilindro intercambiable con los candados SF40.
- Disponible en cuatro colores diferentes.
- Adecuado como elemento de seguridad y señalización en trabajos de mantenimiento e instalaciones productivas.
- Sistema de retención de llave con el candado abierto.
- Se suministra con 2 llaves.
- Llave compatible con candados SF40.

- Anodized aluminium body and hardened steel shackle.
- Interchangeable cylinder with all the SF40 padlock's versions.
- Available in four different colours.
- Suitable as a security and signal element for maintenance and production installations.
- Key retention system when the padlock is open.
- Ideal product for PMI and Multiple Cable hasps and staples.
- Supplied with 2 keys. Compatible key with SF40 padlocks.

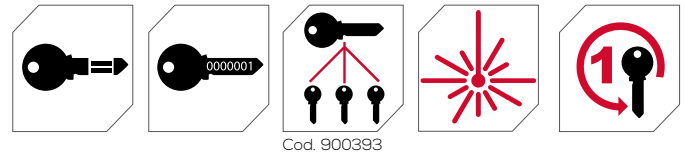

Cod. 900393

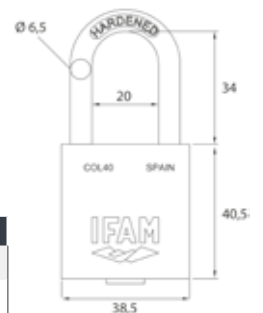

Ref.	Cl.	Cod.		Pack	Uni.
COL40B	■	044600B			6
COL40B KN	■	044607B			6
COL40N	■	044600N			6
COL40N KN	■	044607N			6
COL40R	■	044600R			6
COL40R KN	■	044607R			6
COL40V	■	044600V			6
COL40V KN	■	044607V			6

## Port. Múltiple Arco Ø4

Mult. Hasp with Shackle Ø4



- Pinza de bloqueo diseñada para espacios reducidos donde es necesario que más de un operario bloquee el equipo o maquinaria.
- Arco de acero de 4mm de diámetro
- Cuerpo fabricado en resina ABS resistente a los agentes químicos y a altas temperaturas.
- Se bloquea con 1 ó 2 candados con diámetro de arco máximo de 7,5 mm.
- Compatible con todos los bloqueos para interruptores de IFAM, así como con todos los candados LOTO de la marca.
- Empleo muy sencillo e intuitivo.

- Hasp designed for confined spaces where more than one operator needs to block the equipment or machinery.
- 4mm diameter steel shackle.
- Body made of ABS resin resistant to chemical agents and high temperatures.
- Locks with 1 or 2 padlocks with a shackle diameter up to 7.5 mm.
- Compatible with all IFAM switch locks and LOTO padlocks.
- Very simple and intuitive use.

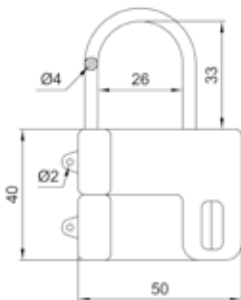

Ref.	Cod.	Pack	Uni.
Portacandados Múltiple Arco Ø 4 Multiple Hasp with Shackle Ø 4	090150		10

## Port. Múltiple Cable Ø4

Cable lockout Ø 4



- Dispositivo con cable separado del cuerpo para una mayor facilidad de uso.
- Cable de acero trenzado de 4mm de espesor y 3m de longitud.
- Dispositivo separado de plástico de color rojo para hacerla fácilmente identificable. Resistente a impactos, altas temperaturas, corrosión y rayos UVA.
- Bloqueo con hasta 6 candados con un diámetro máximo de 7mm.

- Device with cable separated from the body for an easier and more comfortable use.
- Stranded steel cable 4mm thick and 3m long.
- Separate plastic device painted red to make it easily identifiable. Resistant to impacts, high temperatures, corrosion and red UVA rays.
- Locking with up to 6 padlocks with shackle diameter up to 7mm.

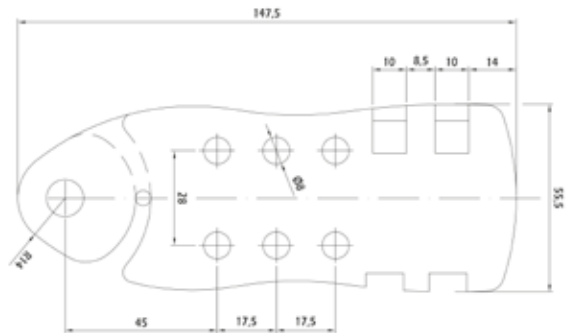

Ref.	Cod.	Pack	Uni.
Portacandados Múltiple Cable Ø 4 Cable lockout Ø 4	090298		5

## Port. Múlt. Cable Ø3 plástico

Mult. Hasp Plastic Cable Ø3



- Cable de acero trenzado de 3 mm. de espesor y 2,4 m. de longitud. Revestimiento de plástico rojo para evitar la corrosión ambiental y la producida por agentes químicos.
- Dispositivo ergonómico de polietileno para facilitar el ajuste del cable.
- Bloqueo mediante un candado con un diámetro de arco máximo de 8 mm.
- Elemento de seguridad para las personas y señalización en trabajos de mantenimiento en instalaciones productivas.

- Braided steel cable; 3 mm thick and 2.4 metre long. Red plastic coated cable for avoiding environmental and chemical corrosion.
- Ergonomic polyethylene device to facilitate adjusting the cable.
- Blockable with a padlock with shackle diameter up to 8mm.
- Used for personnel safety purposes and for maintenance and production installations.

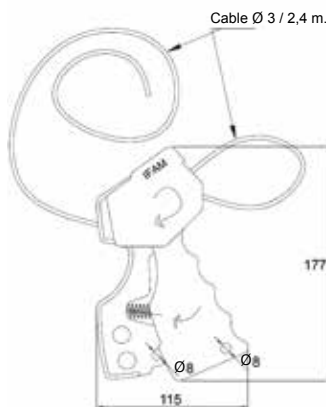

Ref.	Cod.	Pack	Uni.
Portacandados Múltiple Cable Ø3 Multiple Hasp Lockout with Plastic Cable Ø3	000468		6

## Bloq. interrup. magnetot.

Thermal-magn. circuit breaker lockouts



A1

A2

- Dispositivos diseñados para bloquear interruptores magnetotérmicos en un cuadro de mandos.
- Fabricados en nylon con carga de fibra de vidrio al 30% para dotarlos de mayor resistencia.
- Pasadores y tornillos de acero inoxidable.
- Resistentes a las sustancias químicas y temperaturas extremas.
- Disponibles para interruptores individuales y multipolares.
- Ajuste mediante sistema de pulsador / tirador. No se precisan herramientas adicionales.
- Bloqueo mediante un candado con diámetro de arco máximo de 6 mm.

- Devices designed to lockout thermal-magnetic switches on a control panel.
- Made from nylon and 30% fibreglass for added resistance.
- Stainless steel bolts and screws.
- Resistant to chemical substances and extreme temperatures.
- Available for individual and multipolar switches.
- Adjustable with button or handle. No additional tools required.
- Lockable with padlocks with shackle diameter up to 6mm.

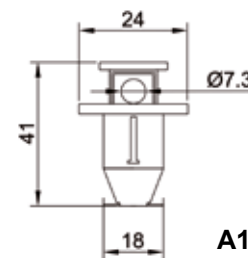

A1

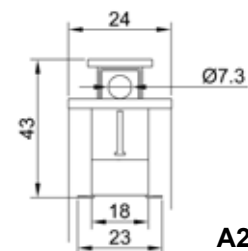

A2

Ref.	Cod.	Pack	Uni.
Bloqueo para interruptor magnetotérmico A1 Thermal-magnetic circuit breaker lockout A1	090200		10
Bloqueo para interruptor magnetotérmico A2 Thermal-magnetic circuit breaker lockout A2	090220		10



## Bloq. válvulas de compuerta

### Gate valve lockouts



- Diseñados en 5 tamaños diferentes para adaptarse a cualquier tipo de válvula de compuerta: Ø 65 mm., Ø 130 mm., Ø 170 mm., Ø 255 mm., Ø 330 mm.
- Fabricados en polímero ABS, altamente resistente a los impactos y al desgaste por abrasión.
- Resistente a temperaturas entre -40°C y 180° C.
- Bloqueo mediante un candado con diámetro de arco máximo de 8,5 mm.
- Incluyen etiquetas adhesivas de señalización de la válvula protegida por el sistema de bloqueo.

- Designed in five different sizes to suit any kind of gate valve: Ø 65 mm, Ø 130 mm, Ø 170 mm, Ø 255 mm and Ø 330 mm.
- Made from high impact and abrasion wear resistant ABS polymer.
- Resistant to temperatures between -40°C and 180°C.
- Lockable with a padlock with shackle diameter up to 8.5mm.
- Includes marking stickers for the valve protected by the locking device.

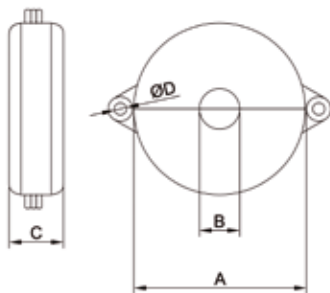

## Estación almacenaje C

### Lockout station C



- Esta estación de almacenamiento es la solución idónea para guardar dispositivos de bloqueo y señalización en grandes instalaciones industriales y productivas.
- Diseñada para ser fijadas en la pared.
- Fabricación en acero y recubiertas de una pintura especial resistente a altas temperaturas, rayos UVA, corrosión y agentes químicos.
- Capacidad para 10 candados.
- Dimensiones:: 270mm base x 80mm. alto x 40mm. fondo.

- This locking station is the ideal solution for storing lockout-tagout devices in great industrial and productive facilities.
- Designed to be fixed on the wall.
- Made of steel and covered by a special paint resistente to high temperatures, UV rays, corrosion and chemical agents.
- Room for 10 padlocks.
- Dimensions: 270mm base x 80mm height x 40mm depth.

Ref.	Cod.	Pack	Uni.
Est. almacenaje C (10 candados) Lockout station C (10 padlocks)	090534		1

Ref.	Cod.	A	B	C	D	Pack	Uni.
Bloqueo válvulas compuerta 25-64 Gate valve lockout 25-64	090340	65	15	30	9		6
Bloqueo válvulas compuerta 64-127 Gate valve lockout 64-127	090350	130	40	40	9		3
Bloqueo válvulas compuerta 127-165 Gate valve lockout 127-165	090360	170	65	45	9		3
Bloqueo válvulas compuerta 165-254 Gate valve lockout 165-254	090370	255	90	60	9		1
Bloqueo válvulas compuerta 254-330 Gate valve lockout 254-330	090380	330	95	70	9		1





# IFAM



## ANTIRROBOS PARA MOTO MOTORCYCLE LOCKS

**CHECKERED  
FLAG**



PAG.  
32

**BASIC**

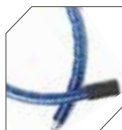

PAG.  
32

**ROOKIE**



PAG.  
33

**STORM  
LOCK NEGRO  
STORM LOCK  
BLACK**



PAG.  
33

**MASTER  
DISK**



PAG.  
34

## Checkered flag



- Eslabones de 10mm de grosor.
- Eslabones de acero templado para una gran resistencia al corte.
- Último eslabon con mayor diámetro para proporcionar un máximo ajuste cuando la cadena se cierra con un candado.
- Forrada con tela de nylon de gran resistencia para evitar el roce con la moto. Forrada con tela de nylon de gran resistencia para proteger de roces la cadena y la propia moto.
- Disponible en tres longitudes: 1,20m y 1,60m.

- Tempered steel links for high cut resistance.
- Link thickness: 10 mm.
- Its final link has a larger diameter to enable maximum adjustment when closing the chain with a padlock.
- Covered with high-resistance nylon to prevent contact between the chain and the motorcycle.
- Available in two lengths: 1.2m and 1.6m.

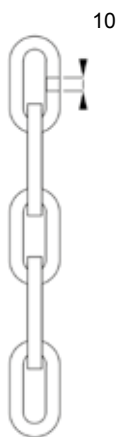

Ref.	Cod.		IPL	Pack	Uni.
Checkered flag 120	000850	1,2 m	7		1
Checkered flag 160	000852	1,6 m	7		1

## Basic



- Antirrobo por sistema de rótulas con revestimiento de plástico para evitar rozaduras.
- Gran flexibilidad de las rótulas, que hace que se pueda enrollar fácilmente para su transporte en la moto.
- Se suministra con dos llaves tubulares con miles de combinaciones.
- Dos longitudes: 1 m. (Basic 100) y 1,20 m. (Basic 120).

- Ball Joint lock with plastic coating to prevent scratching the motorcycle and the lock itself.
- Great flexibility, which makes it easy to roll the device up and to transport it on the motorcycle.
- Supplied with two tubular keys .
- Two lengths available: 1 m. (Basic 100) and 1.20 m. (Basic 120).

Ref.	Cod.		IPL	Pack	Uni.
Basic 100	048100	1 m	6		1
Basic 200	048120	1,2 m	6		1

## Rookie



- Cuerpo con doble anclaje de refuerzo en V.
- Cuerpo de aleación de zinc.
- Cerradura automática de llave de puntos con miles de combinaciones y pasador anti-taladro.
- Pasador de acero endurecido. Diámetro: 5,5 mm.
- Disponible en 3 colores: negro, amarillo y rojo.
- Recubierto por una gruesa capa de pintura para evitar su oxidación.
- Válido para su uso tanto en interior como en exterior.
- Se suministra con tres 3 llaves de puntos de seguridad.

- V-shaped double-anchor body.
- Body made from zinc alloy.
- Automatic dimple key lock with thousands of combinations and a drill-resistant shackle pin.
- Supplied with three dimple keys.
- Hardened steel shackle pin. Diameter: 5.5 mm.
- Available in 3 colours: black, yellow and red.
- Coated in a thick layer of paint to avoid rust.
- Suitable for both indoor and outdoor use.
- Key compatible with Wild Card and Custom Steel 50.

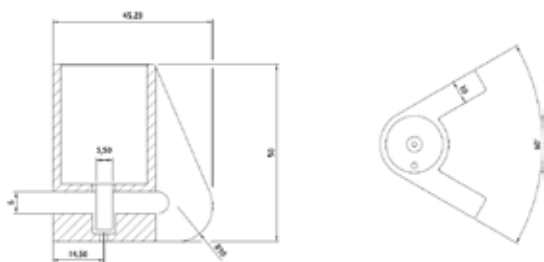

Ref.	Cl.	Cod.	Pack	Uni.
Rookie	■	053010A	📦	12
Rookie	■	053010N	📦	12
Rookie	■	053010R	📦	12

## Storm Lock negro

### Storm Lock black



**INFO** | CATÁLOGO GENERAL  
 PAG 78 | GENERAL CATALOGUE

- Sistema de alarma (110 dbA). Sensor de movimiento que alerta de la manipulación del antirrobo.
- Pasador de acero de 7 mm. de diámetro.
- Cuerpo de aleación de zinc niquelado y cromado o pintado.
- Suministrado con 2 llaves de regata.
- Funda resistente de tela y juego de pilas de repuesto.
- Se suministra con llave de apertura para facilitar el cambio de pilas.

- Alarm system (110 dbA). Movement sensor alerting about possible thefts.
- Steel shackle pin measuring 7 mm in diameter.
- Body made of a nickel zinc and chrome plated alloy or painted.
- Supplied with 2 laser keys.
- Resistant cloth bag and set of spare batteries.
- Available in 3 colours: chrome, red and black (NEW).

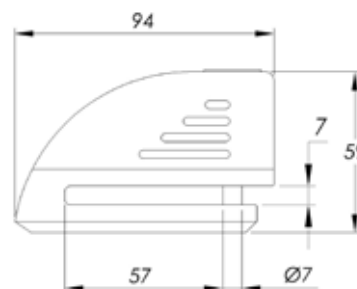

Ref.	Cl.	Cod.	Pack	Uni.
Storm Lock	■	053106N	📦	4

## Master Disk



- Cuerpo de aleación de zinc niquelado y cromado.
- Arco de 11 mm. de diámetro.
- Cerradura de discos con miles de combinaciones.
- Protector de cuerpo resistente.
- Suministrado con 3 llaves de discos, una de ellas con LED luminoso para visión nocturna.
- Incluye funda de tela y cable recordatorio.
- Body made of zinc alloy., chromed and nickel plated.
- Shackle measuring 11 mm in diameter.
- Disc type lock with thousands of differs.
- Resistant body protector.
- Supplied with 3 disc type keys; one of them with an LED for night vision.
- Includes a cloth bag and spiral type cable.

Ref.	Cod.	Pack	Uni.
Master Disk	053045C		1



# IFAM



## ANTIRROBOS PARA BICICLETA BICYCLE LOCKS

**BERLIN**



PAG.  
36

**KIT BERLIN+  
WP45**



PAG.  
36

## Berlin



- Cadenas de acero galvanizado.
- Suministradas con o sin candado.
- Funda de tela para una mayor resistencia a la humedad y a los roces.
- Diámetro de los eslabones: 5 mm. (Berlin 5x600, Berlin 5x750), 6 mm. (Berlin 6x1000) y 7 mm (Berlin 7x1250).
- Gran flexibilidad.

- Galvanised steel chains.
- Supplied with or without padlock.
- Lined with cloth for higher resistant to humidity and to scratches.
- Links' diameter: 5mm (Berlin 5x600, Berlin 5x750), 6mm (Berlin 6x1000) and 7mm (Berlin 7x1250).
- High flexibility.

Ref.	Cod.		Pack	Uni.
Berlin 5x600	000870	60cm		1
Berlin 5x750	000872	75cm		1
Berlin 6x1000	000874	100cm		1
Berlin 7x1250	000876	125cm		1

## Kit Berlin + WP45



### CADENAS BERLÍN

- Cadenas de acero galvanizado.
  - Funda de tela para una mayor resistencia a la humedad y a los roces.
- ### CANDADO WP45
- Cuerpo de láminas de acero recubierto por una funda termoplástica hermética.
  - Arco de acero endurecido y cromado con cubierta termoplástica.
  - Tapa aislante para protección del cilindro.
  - Especialmente indicado para exteriores y zonas a la intemperie: WP (Weather Proof).
  - Se suministra con 2 llaves.

### BERLIN CHAINS

- Galvanised steel chains.
- Lined with cloth for higher resistance to humidity and to scratches.

### WP45 PADLOCK

- Hardened steel laminated body protected by a hermetic thermoplastic casing.
- Hardened steel chromed shackled covered by a thermoplastic casing.
- Cylinder protected by an isolating lid.
- Specially recommended for outdoors: WP (Weather Proof).
- Supplied with 2 keys.

Ref.	Cod.		Pack	Uni.
Berlin 5x600 + WP45	000960	60cm		1
Berlin 5x750 + WP45	000962	75cm		1
Berlin 6x1000 + WP45	000964	100cm		1
Berlin 7x1250 + WP45	000966	125cm		1









# IFAM



IFAM WORLDWIDE

## IFAM Group - Headquarters

Notario Etxagibel, 4  
20500 Arrasate-Mondragón  
Gipuzkoa - Spain  
Tel.: +34 943 71 21 21  
Fax: +34 943 79 21 78  
www.**ifam**.biz

## IFAM Spain

IFAM SEGURIDAD, S.L.U.  
Notario Etxagibel, 4  
20500 Arrasate-Mondragón  
Gipuzkoa  
Tel.: +34 943 71 21 21  
Fax: +34 943 79 21 78  
www.**ifam**.es  
ifam@ifam.es

## IFAM France

IFAM FRANCE SARL.  
5, rue de Betnoms.  
33185. Le Haillan.  
Bordeaux  
Tel.: +33 05 56 559 688  
Fax: +33 05 56 559 368  
www.**ifam**france.com  
commercial@ifamfrance.com

## IFAM UK

SKS LTD.  
Unit 2 Canalside. Northbridge Road  
Berkhamsted (Hertfordshire)  
HP4 1EG  
Tel.: +44 192 326 333  
www.**ifam**.co.uk  
info@ifam.co.uk

## IFAM Colombia

IFAM COLOMBIA, S.A.S.  
Diagonal 115A # 70B-45 Local 1  
Bogotá  
Tels.: +57 1 5333246  
+57 3203497446  
www.**ifam**.com.co  
info@ifam.com.co

Member of  
**Altuna Group**



www.**ifam**.es



8 420078 457827

